



PLİSE SİNEKLİK
SİSTEMLERİ

SİNEKLİK & PERDE SİSTEMLERİ

FLY SCREEN AND CURTAIN SYSTEMS



**PLİSE SİNEKLİK
SİSTEMLERİ**

**SİNEKLİK & PERDE
SİSTEMLERİ**

FLY SCREEN AND CURTAIN SYSTEMS

www.akplise.com

PLİSE SİNEKLİK PERDE SİSTEMLERİ
FLY SCREEN AND CURTAIN SYSTEMS



**ÜRETMEK
ARTIK ÇOK KOLAY**
IT IS VERY EASY TO PRODUCING NOW

HAKIMIZDA / ABOUT US

AK Plise Sineklik ve Perde Sistemleri 2018 yılında kurulmuştur. Kurucularının Sektöre dair geniş tecrübelerini ve arge çalışmalarını; üretim ve pazarlama ağı ile hizmete sunmayı hedefleyen şirket, profesyonel ekip anlayışıyla kısa süre içerisinde önemli bir Pazar payına sahip olmuştur. Yapmış olduğu faaliyetlerin %80'lik kısmını ihraç ederek şehrine ve ülkesine önemli ekonomik katkı sağlamaktadır.

Her geçen gün kazancını Öz sermayeye aktararak kısa sürede sektörde önemli bir yere gelmiştir. Gelmeye devam edecektir.

İstanbul Sultanbeyli de geniş ürün yelpazesi ve görevinde uzman personeliyle ticaretine devam etmektedir.

AK Plise Firması sektöründe bayilerine bütün ihtiyaç kalemlerini tedarik eden tek firmadır.

AK Fly Screen & Curtain Systems was established in 2018. Combining the founders' vast experience in the sector with R&D studies; With a strong production and marketing network and a professional team understanding, The Company has gained a significant share in the market in a short time.

Company; by exporting about 80% of the goods it produces, it makes a great contribution to their city and the country's economy.

By transferring its earnings to its capital, the company has reached an important place in the sector in a short time; and will continue to grow with sure steps.

Our company based in Istanbul Sultanbeyli; continues its trade with its wide product range and expert staff. And we would like to proudly inform you that we are the only company in the sector that can supply all the necessary items to its dealers.



Bilgi ve
Detay için



www.akplise.com

AK PLİSE SİNEKLİK SİSTEMLERİ



Tasarım esnekliği, özgün renk tonları ile neredeyse herşeyi kapatabilirsiniz... (cam balkondan pencereye kadar) 40 farklı renk seçeneği ile cam balkon ve pencere tasarımında sınır yok... Fikirlerinizi gerçekleştirmek için bir çözüm bulacaksınız...

With its design flexibility and original color tones, you can close everything from the Glass Balcony to the window. With 40 different color options, there is no limit in Glass Balcony and window design! To realize your ideas, you will find a solution!



Sizin için daha kolay ve kaliteli üretmeniz için profesyonelsistem tasarımı gerçekleştirilmektedir. Sadeceirtibata geçmeniz yeterli...

Professional system design is carried out so that we can produce easier and higher quality for you. You just need to contact...



Sistem tasarımında üretmekten satışa giden yolda sürdürülebilirlik ve kolay satış için çalışıyoruz... Yapmanız gereken üretmeye karar vermek...

We work for sustainability and easy sales on the way from production to sales in system design... All you have to do is decide to produce...

MİSYONUMUZ / OUR MISSION

Ülkemizin özkaynaklarından faydalanarak; insana verdiğimiz değer ve yaşam standartlarının geliştirilmesine olan inancımız ile kalite ve güven değerlerimizi birleştirerek daima en iyi geliştirme, üretmek ve sunmak adına bulunduğumuz sektörlere hizmet etmek.

By making use of our country's own resources; To serve the sectors we are in in order to always develop, produce and present the best product by combining our values of quality and trust with the value we give to people and our belief in the development of living standards

VİZYON / VISION

Geliştirdiğimiz, ürettiğimiz ve sunduğumuz tüm hizmetlerde; ahlaki değerlerimizden ödün vermeden en yüksek kaliteyi ekonomik çözümler ile yakalayarak müşteri memnuniyeti sağlamak ve bu memnuniyetin devamlılığını oluşturacak düşüncelere örnek olmaktır.

In all the services we develop, produce and offer; To ensure customer satisfaction by catching the highest quality with economical solutions without compromising our moral values and to be a pioneer in the thoughts that will create the continuity of this satisfaction

HEDEFLER / TARGETS

Her geçen gün gerek yurt içi gerek yurt dışı üretim ve pazarlama faaliyetlerini arttırarak ülkemize istihdam anlamında faydalı olmak ekonomik katkılar sağlamak ve sektörün öncü kuruluşu olmak.

Our goal is to increase domestic and foreign production and marketing activities day by day and to provide economic contribution as one of the leading companies in the sector in order to provide employment to our country.

İÇİNDEKİLER

SİNEKLİK SİSTEMLERİ FLY SCREEN SYSTEMS

27 MM SERİ	06 - 23
27 MM SERIES	
18 MM SERİ	24 - 41
18 MM SERIES	
İÇTEN TAKMA SERİ	42 - 55
INTERIOR-MOUNTED SERIES	
17x25 SERİ	56 - 59
17x25 SERIES	

PERDE SİSTEMLERİ CURTAIN SYSTEMS

LINA SERİSİ	60 - 65
HIRA SERİSİ	66 - 67
YAZ SERİSİ	68 - 69
GÜNEŞ SERİSİ	70 - 71
HİLAL SERİSİ	72 - 73
BAHAR SERİSİ	74 - 75
VEGA SERİSİ	76 - 77
TAVAN PERDESİ / CAM BALKON	78 - 81
ISICAM BALKON SİSTEMLERİ	82 - 87
KARAVAN PERDE SİSTEMLERİ	88 - 92
ÜRETİM PARKURU	93 - 95
SERTİFİKALAR / ÜRETİM HATTI	96 - 97





27 MM SERİ ÜRÜN BİLEŞENLERİ

27 MM SERIES PRODUCT COMPONENTS

FLY SCREEN SYSTEMS

27mm - **NORMAL** / 27mm - **WITH THRESHOLD**

01



27 MM KASA PROFİLİ

27 MM CASE PROFILE

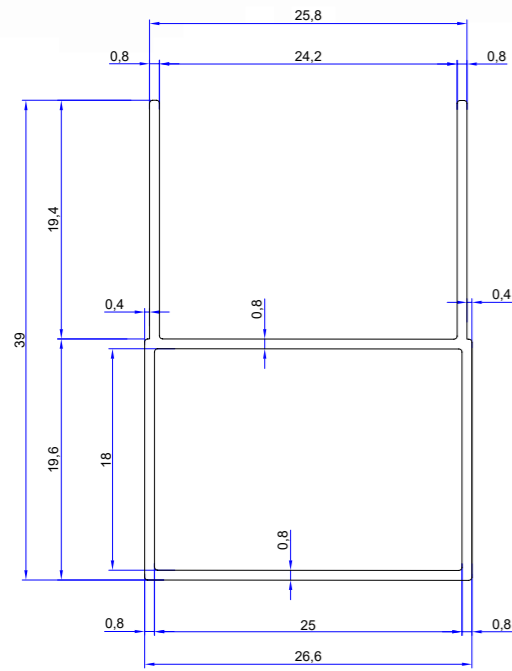

Alüminyum ekstrüzyon sıcak olarak yapılır. Üretim sırasında 6063 serisi biletler kullanılır. Biletler 420-520°C'de ısıtılır, kalıplar 450°C ısıtılmış olmalıdır ve presten çıkan profilin sıcaklığı 500°C nin üzerindedir. Ekstrüzyondan çıkan profil soğutulur, soğuk germe işlemi yapılır ve istenen boyda kesilir. Daha sonra ısıtım işlemi uygulanarak profillere mukavemet kazandırılır. Bu işlem esnasında profiller 185°C'de 5 saat tutulur. Mukavemet kazanan profiller müşteri talebine göre toz boya hattına, eloksal hattına, ahşap transfer hattına veyahut mekanik işlem hattına gider. Uygulanan gerekli işlemler sonrası profiller sevke hazır hale gelir.

Kasa profili: 27 mm derinlik 39 mm ön yüzey genişliğiyle tok bir görünüm sağlar. Plise sinekliğin ana profili diyebiliriz. Köşe takozlarının birleştirilmesiyle Plise sinekliğin iskeletini oluşturur diyebiliriz.

It is produced in an aluminum extrusion mold. 6063 series billets are used during production. Billets are heated at 420-520°C, molds

It must be heated to 450°C and the temperature of the profile coming out of the press is above 500°C. The profile coming out of the extrusion is cooled, cold stretching is performed and cut to the desired length. Then, the profiles are strengthened by applying heat treatment. During this process

Profiles are kept at 185°C for 5 hours. Profiles that gain strength can be applied to powder coating line, anodized line, wooden goes to the transfer line or mechanical processing line. After the necessary processes are applied, the profiles are ready for shipment.

The case profile provides a solid appearance with a depth of 27 mm and a front surface width of 39 mm. We can call this profile the main profile of "Pleat Fly Screen". By combining the corner wedges, the skeleton of the pleated mosquito net is formed.

27 MM KANAT PROFİLİ TEKNİK ÖZELLİKLERİ

27 MM WING PROFILE TECHNICAL SPECIFICATIONS

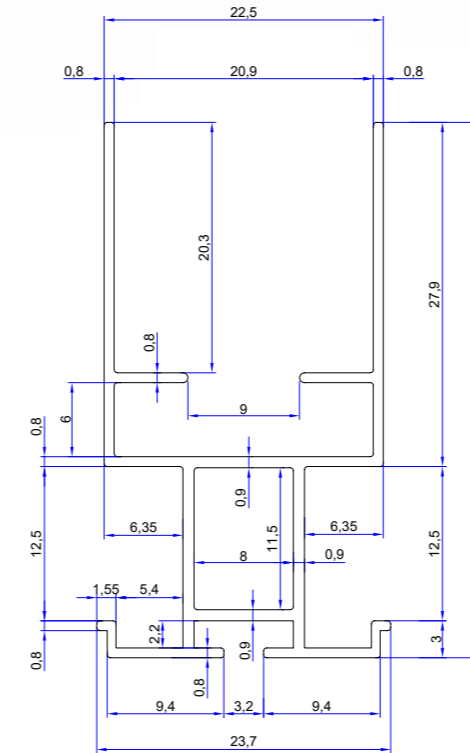

Kanat Profili: Kasa profiliyle uyumlu baş kısımlarına takılan teker aksesuarları sayesinde plise tülün hareket etmesini sağlayan profildir. Özel tasarımıyla tülü içine hapsederek tülün uzun ömürlü olmasını sağlar.

Wing Profile: It is the profile that allows the plisse polyester mesh to move owing to the wheel accessories attached to the head parts compatible with the frame profile. With its special design, it ensures that the plisse polyester mesh is long-lasting by trapping the mesh inside.

TUL :17 ve 19 MM
Tulle: 17 and 19 MM

ŞERİT 19 MM
STRIP 19 MM

ÜRÜN TEKNİK AÇIKLAMASI

ÜRÜN ADI	Özel tasarım polyester file
DOKUMA YAPISI	Pileli
RENK	Gri-siyah
İPLİK ÇAPI (MM) Çözgü :	0.3+/-0.02mm atkı:0.3+/- 0.02mm
BİTİŞ YOĞUNLUĞU (ENDS/İNÇ) Çözgü	18 atkı : 16
ALAN AĞIRLIĞI (G/M2)	70 g/m2 :+/-5 g/m2
BİLEŞİM	Polyester
KIRMA KUVVETİ (N/25MM) Çözgü:	>180 atkı: >160
STANDART İLE (M)	2m / 2.2m/ 2.4m /2.7m/ 3m'den itibaren
STANDART PARÇA UZUNLUĞU (M)	26m'den itibaren:+/- 1m
DAYANIKLILIK ISI	-10 derece /+50 derece
PARÇA UZUNLUĞU (PC)	Talep üzerine temin edilebilir

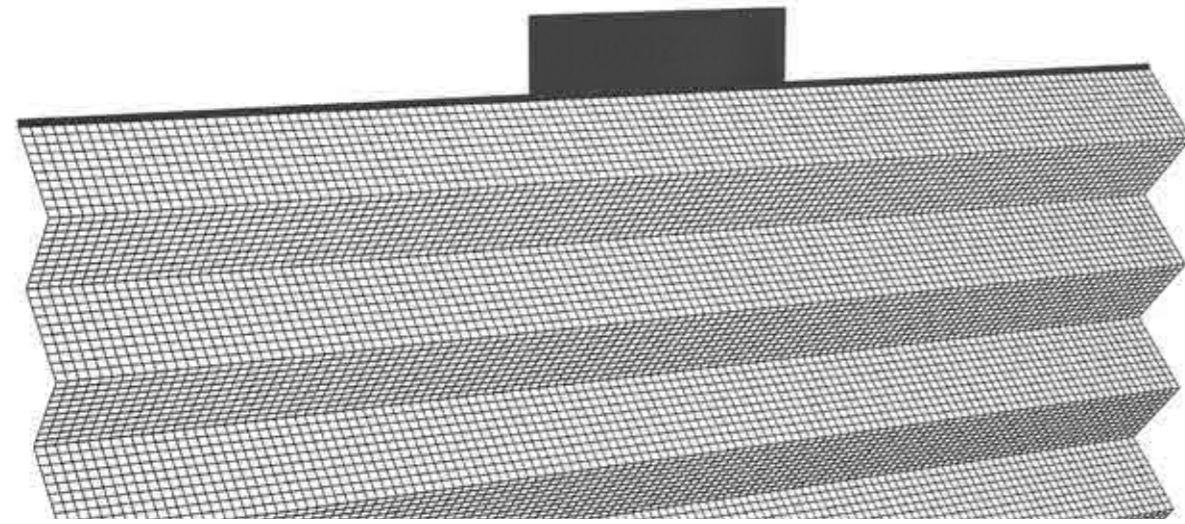

PRODUCT TECHNICAL DESCRIPTION

PRODUCT NAME	Special design polyester mesh
WEAVING STRUCTURE	Pleated
COLOR	Grey - Black
YARN DIAMETER (MM)	Warp : 0,3+/-0,02mm weft:0,3+/- 0,02mm
ENDS DENSITY (ENDS/INCH)	8 WEFT : 16
AREA WEIGHT (G/M2)	70 g/m2 :+/-5 g/m2
COMPOUND	Polyester
BREAKING FORCE (N/25MM)	180 WEFT: > 160
STANDARD WITH (M)	From 2m / 2,2m/ 2,4m /2,7m/ 3m
STANDARD PART LENGTH (M)	From 26 meters +/- 1m
HEAT RESISTANCE	-10 degree /+50 degree
PART LENGTH (PC)	Available on request

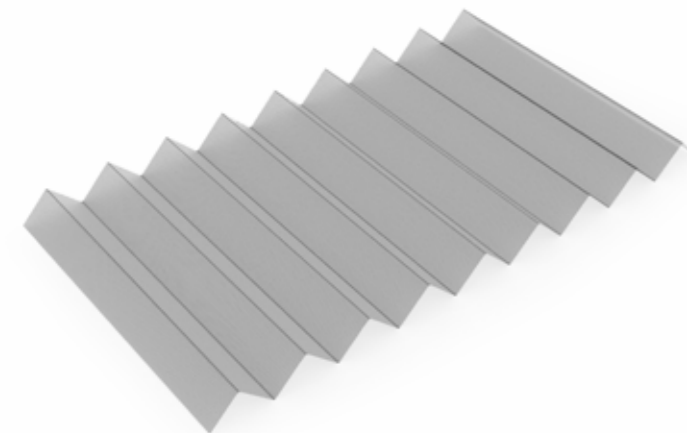

Plise Sineklik Pvc Bantlı Şerit sinekliğin tülüne yapıştırılarak tül ile alüminyum bağlantısını sağlamaktadır. Bu ürünün en büyük özelliği ısıya karşı dayanıklı Pvc malzemeden üretilmesidir. Üzerindeki çift taraflı bant dış hava şartlarında, sıcakta ve soğukta özelliğini yitirmemesidir. Pvc Şeritler üretildikten sonra firmamız tarafından sıcak hava şartlarında dayanıklılığı kontrol edilmekte ve bu ürün için özel üretilen bantlar yapıştırılmaktadır. **AK PLİSE** markalı Pvc Şeritlerin **10 yıl garanti** süresi vardır.

Plise Fly Screen Pvc Taped Strip is attached to the tulle of the fly screen and provides the aluminum connection with the tulle. The biggest feature of this product is that it is produced from heat resistant PVC material. The double-sided tape on it does not lose its exterior, hot and cold properties. After the PVC Strips are produced, their strength is checked by our company in hot weather conditions and the tapes specially produced for this product are adhered. AK PLİSE branded PVC Strips have a warranty period of 10 years.

İP
ROPE



Sineklik sistemlerinin en önemli bileşenlerinden biri olan sineklik ipleri mekanizmanın sorunsuz çalışabilmesi için pek çok bitirme işleminden geçirilmektedir.

Kullanım sırasında tül sisteminin formunun bozulmasını engellemek için ısı işleminden geçirilmekte uzaması azaltılmakta ve sürtünme dayanımı artırılmaktadır.

Fly screen ropes, one of the most important components of mosquito net systems, are subjected to many finishing processes in order for the mechanism to work smoothly. In order to prevent the form of the tulle system from deteriorating during use, it is heat treated and elongated. Its reduced and frictional resistance is increased.

KASA VE KANAT BİLEŞENLERİ

CASE AND WING COMPONENTS

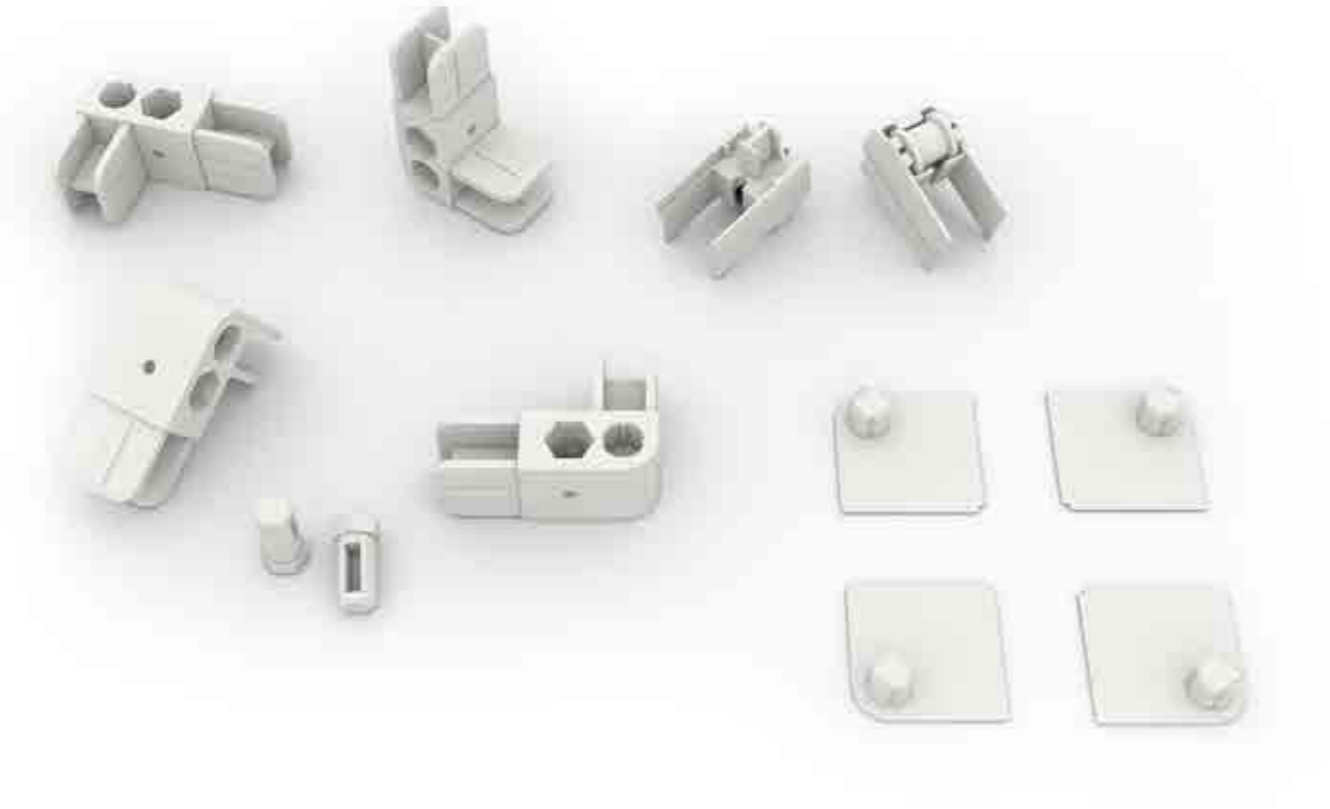

27 MM AKSESUAR SİSTEMLERİ

27MM ACCESSORY SYSTEMS



Köşe Takozu / Corner Wedge

Yatay ve Dikey Kasa profil kesitlerinin birleşmesinde kullanılan orijinal moblen hammadde ile üretilmektedir.

It is produced with the original moblen raw material used in the union of the Horizontal and Vertical Frame profile sections.



Rulman Teker / Bearing Wheel

Sistemde Yatay ve Dikey olarak kullanılan kanat profilinin baş kısımlarında kullanılmaktadır. İçerisinde bulundurduğu derlin hammadde ve demir pim sistemi sayesinde kolay açılıp kapanmaya yarayan plastik enjeksiyon ürünüdür.

It is used in the head parts of the wing profile, which is used horizontally and vertically in the system. It is a plastic injection product for easy opening and closing thanks to the deep raw material it contains and the iron pin system.



Pim Birleşimi / Pin Joint

Dikey ve yatay profillerin birleşiminde kullanılan köşe takozunun merkez noktasından geçen plise sineklik kord ip'in geçişinde kullanılan çevresinde kullanılan dikey çıkıntılar sayesinde sıkıştırmasını sağlayan kitleme pimi özel baskı tekniği ve orijinal hammadde kullanılarak yapılan plastik enjeksiyon ürünüdür.

The pleated fly screen passing through the center point of the corner wedge used in the union of the vertical and horizontal profiles, the locking pin used in the passage of the rope and used around it, which enables it to be compressed thanks to the vertical protrusions, is a plastic injection product made using the special printing technique and original raw material.

KÖŞE KAPAKLARI / CORNER COVERS

Montaj bitiminde köşe aksesuarlarının vida deliklerinin kapatılmasında kullanılır ve estetik bir görünüm sağlar.

It is used to close the screw holes of the corner accessories at the end of the assembly and provides an aesthetic appearance.

KASA VE KANAT BİRLEŞİM PARÇALARI

CASE AND WING JOINT COMPONENTS

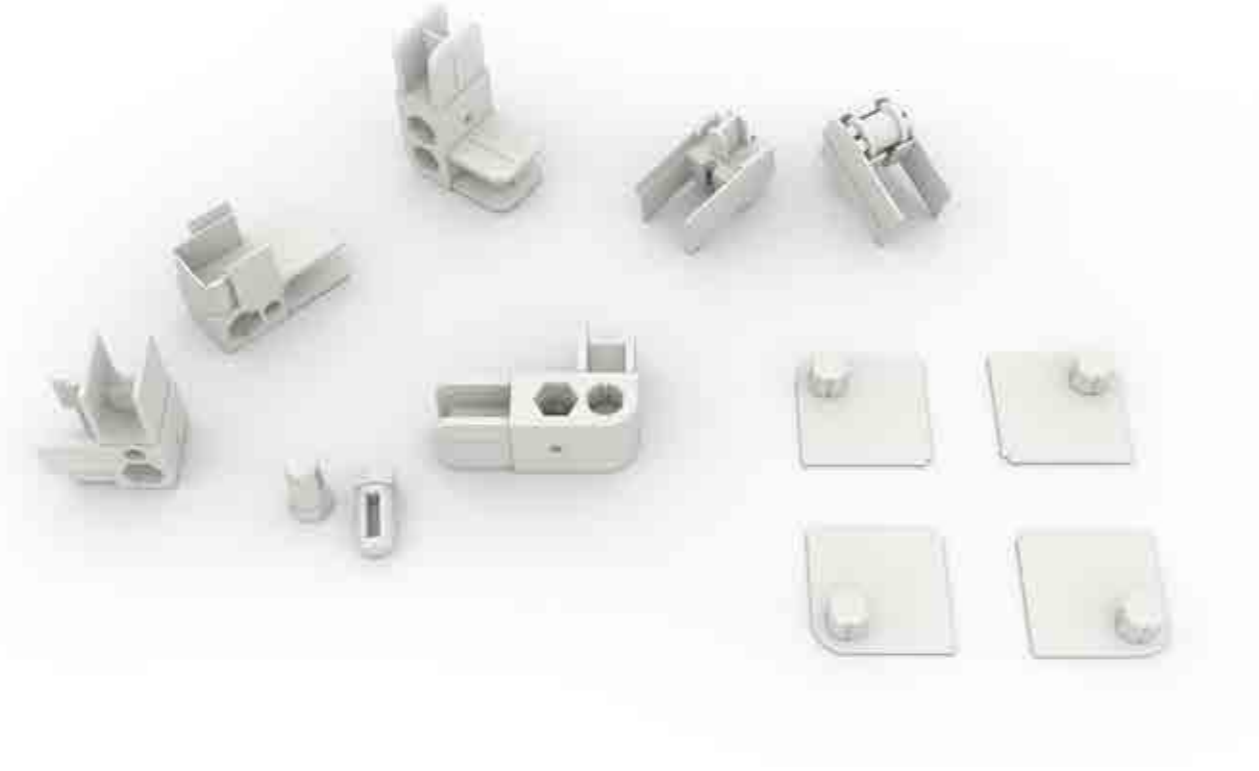

EŞİKSİZ PROFİL

NON-THRESHOLD PROFILE

Genellikle kapı sinekliklerinde kullanılır. İnsan çıkışının çok olduğu yerlerde ayak takılmasını engeller sert özelliğinden dolayı deforme olmaz, uzun bir kullanım sağlar. Genel kullanım alanı bahçe, teras çıkışlarında kullanımı idealdir.

Beyaz, Antrasit Gri ve ,Eloksal olmak üzere 3 renk çeşidi mevcuttur.

It is generally used in door screens. It prevents the feet from being stuck in places where there is a lot of human exit. It does not deform due to its hard feature, it provides a long use. It is used in general usage area garden and terrace exits. There are 3 types as White, Anthracite Gray and Anodized

There are 3 types available as White, Anthracite Gray and Anodized



Köşe Takozu / Corner Wedge

Yatay ve Dikey Kasa profil kesitlerinin birleşmesinde kullanılan orijinal moblen hammadde ile üretilmektedir.

It is produced with the original moblen raw material used in the union of the Horizontal and Vertical Frame profile sections.



Rulman Teker / Bearing Wheel

Sistemde Yatay ve Dikey olarak kullanılan kanat profilinin baş kısımlarında kullanılmaktadır. İçerisinde bulundurduğu derlin hammadde ve demir pim sistemi sayesinde kolay açılıp kapanmaya yarayan plastik enjeksiyon ürünüdür.

It is used in the head parts of the wing profile, which is used horizontally and vertically in the system. It is a plastic injection product for easy opening and closing thanks to the deep raw material it contains and the iron pin system



Pim Birleşimi / Pin Joint

Dikey ve yatay profillerin birleşiminde kullanılan köşe takozunun merkez noktasından geçen plise sineklik kord ip'in geçişinde kullanılan çevresinde kullanılan dikey çıkıntılar sayesinde sıkıştırmasını sağlayan kitleme pimi özel baskı tekniği ve orijinal hammadde kullanılarak yapılan plastik enjeksiyon ürünüdür.

The pleated fly screen passing through the center point of the corner wedge used in the union of the vertical and horizontal profiles, the locking pin used in the passage of the rope and used around it, which enables it to be compressed thanks to the vertical protrusions, is a plastic injection product made using the special printing technique and original raw material

Köşe Kapakları / Corner Covers

Montaj bitiminde köşe aksesuarlarının vida deliklerinin kapatılmasında kullanılır ve estetik bir görünüm sağlar.

It is used to close the screw holes of the corner accessories at the end of the assembly and provides an aesthetic appearance.



KIL FITİLİ WEATHER STRIP

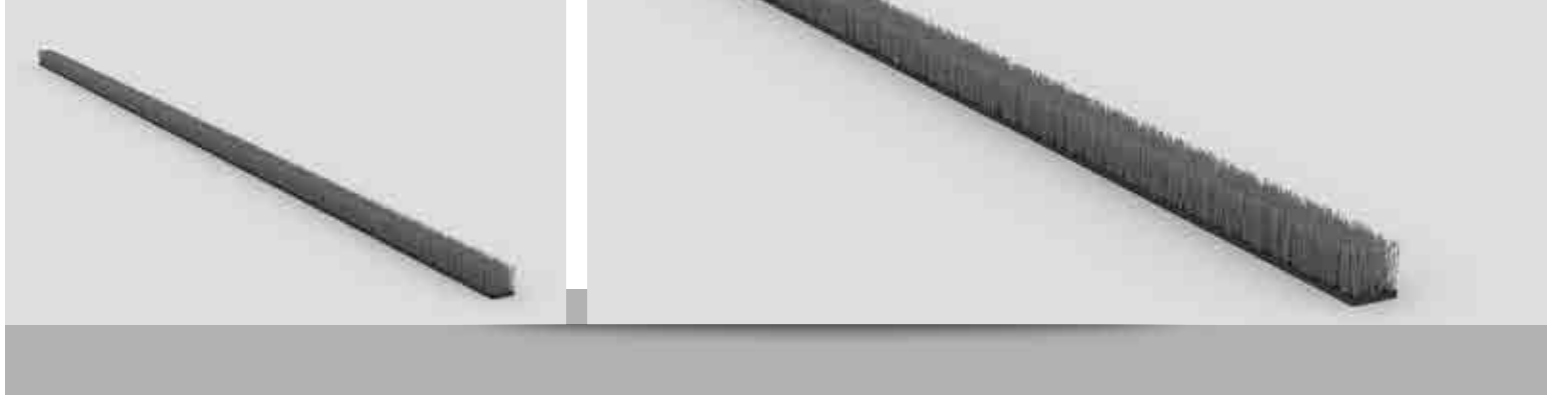

Standart kapı ve pencere sinekliklerinde kullanılan kanat profillerinin mıknatis kısmı için kullanılan özel boşluğun kapatılmasında kullanılır. Çok önemli özelliği olmamakla birlikte estetik açısından güzel bir görünüm sağlar ve kısmen sineklikte oluşabilecek tozlanmayı ve kirlenmeyi önler.

It is used to close the special space used for the magnetic part of the sash profiles used in standard door and window fly screens. Although it is not a very important feature, it provides a beautiful appearance in terms of aesthetics and is partially in the mosquito net. It prevent dusting and contamination that may occur.

MIKNATIS STRAIGHT MAGNET AND TRIANGLE MAGNET



Düz ve üçgen mıknatis; belli bir standartın üstündeki ölçülerde sistemin sağlıklı çalışabilmesi adına bir takım değişiklikler yapılır.Önemli detaylardan birisi büyük ölçülerde kullandığımızı duble sistemdir,daha kolay bir kullanım sağlar, çift taraflı kanat kullanılır.Mıknatis iki kanadın birleşiminde kullanılır.Kanat Profilinin özel kanalına takılarak sistemin çalışmasını sağlar,düz ve üçgen mıknatis tercih sebebidir,üçgen mıknatisin bir özelliği üretim sırasında oluşabilecek sistemin çalışmasını engellemeyecek ufak hataların giderilmesinde önemlidir.

Flat and triangular magnets; in measurements above a certain standard, some changes are made in order for the system to work healthily. One of the important details is the double system we use in large sizes, it provides an easier use and double-sided wing is used. It allows it to work. Flat and triangular magnets are preferred, the triangular magnet feature does not prevent the system from working during production and allows minor errors to be eliminated.

KUŞ GÖZÜ EYELET



Plise sinekliğin ip'in geçişinde kullanılan sineklik ve perde ürünlerinde kullanabileceğiniz metal özel kaplamalı kuşgözü kapsül. Bu ürünü tulumba presinde ve otomatik makinalarda delici ve çakma kalıpları kullanarak uygulayabilirsiniz. Ürün sac malzemedir yapılmış, ve alüminyum kaplamadır.

It is a metal specially coated capsule that you can use in fly screen systems and curtain products used in the passage of pleated fly screen systems. You can apply this product in pump presses and automatic machines by using piercing and hammering dies. The product is made of sheet material and has an aluminum coating.

MANTAR BAŞLIK VİDA CORK HEAD SCREW



Mantar başlı üretim vidası; Şerite yapıştırılan tülün kasa profiline sabitlemesinde kullanılır,en önemli özelliği geniş başlı olması sebebiyle tülün yırtılmasına engel olur ve güçlü bir mukavemet sağlar.

Cork Head Screw, is used to fix the plisse polyester mesh attached to the strip, to the frame profile. The most important feature, owing to its wide head, prevents the polyester mesh from tearing and provides a strong strength.

27 MM NORMAL
27 MM NORMAL

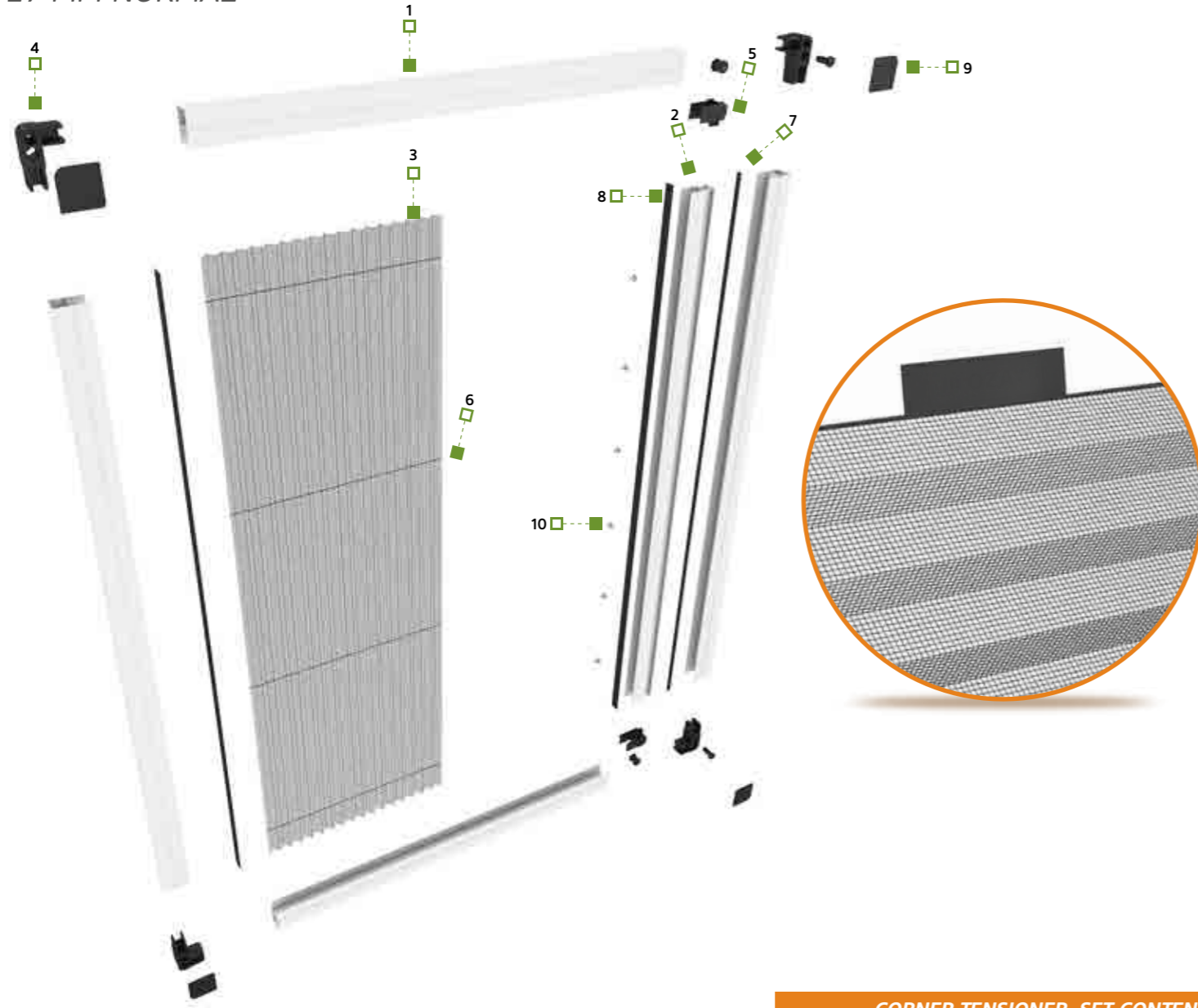

27 MM ESİKSİZ
27 MM NON-THRESHOLD

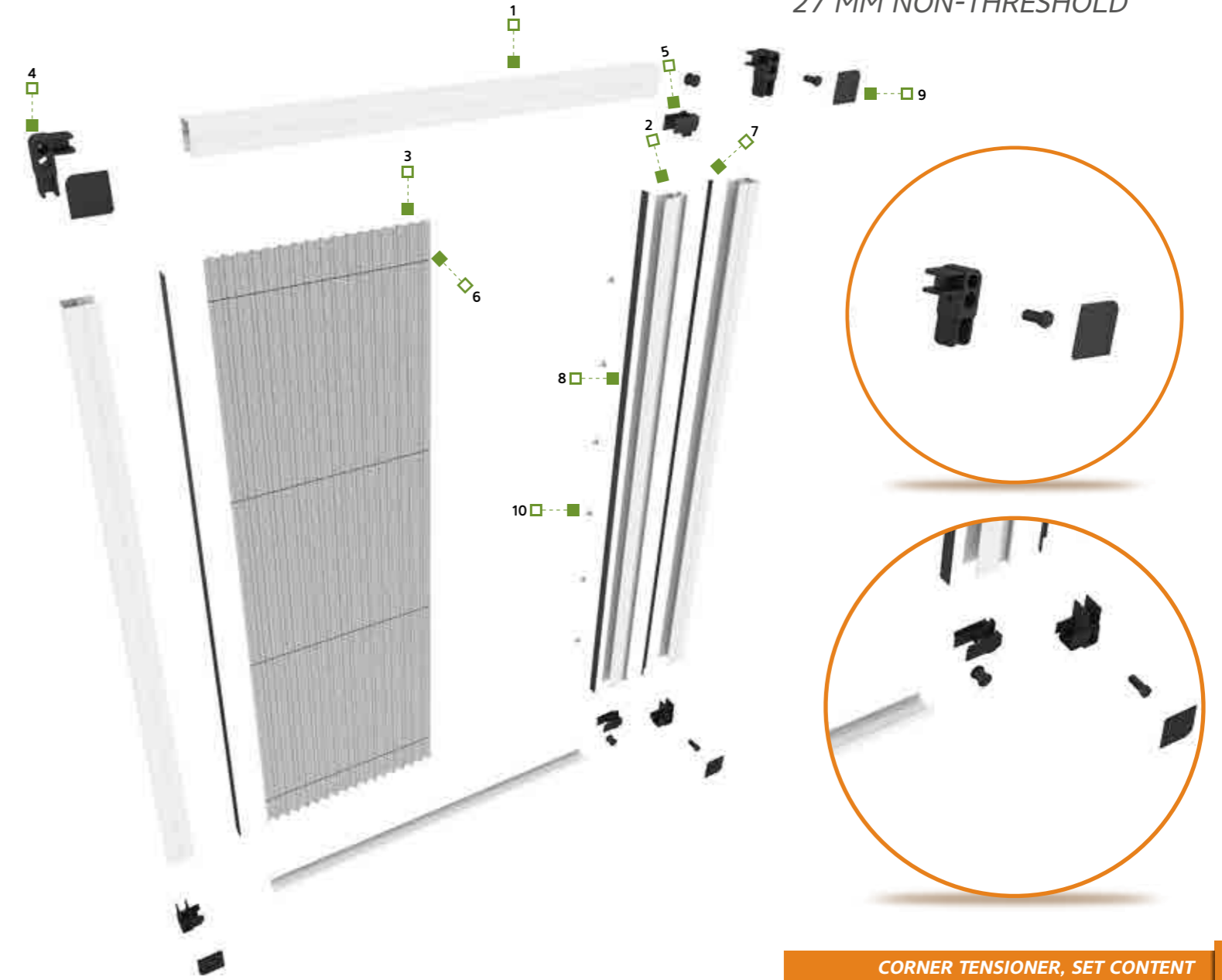

Özellikle kapılar için çok tercih edilen bir seridir, tül ağı bir tarafta veya her iki tarafta kasa içerisine katlanır.

Pileli kaset, alüminyum kasa profili ile kapı veya pencere pervazına, köşe takozlarında yer alan montaj deliklerinden vida yardımıyla doğrudan ve kolayca sabitlenir.

It is a very preferred series especially for doors, the tulle net is on one side or on each side. It can be folded into the case on both sides. Pleated case, aluminum frame profile and door or window sill, corner directly with the help of screws through the mounting holes in the easily fixed

CORNER TENSIONER, SET CONTENT

SIRA NO		
1	Kasa	Till
2	Kanat	Wing
3	Tül	Mesh
4	Köşe Aksesuarı	Corner Accessory
5	Rulman Aksesuarı	Bearing Accessory
6	Gergi İpi	Tension Rope
7	Kıl Fıtlı	Weather Strip
8	PVC Şerit	PVC Strip
9	Montaj Kapağı	Mounting Cover
10	Kuş Gözü	Eyelet

Genellikle kapı sinekliklerinde kullanılır. İnsan çıkışının çok olduğu yerlerde ayak takılmasını engeller sert özelliğinden dolayı deforme olmaz, uzun bir kullanım sağlar. Genel kullanım alanı bahçe, teras çıkışlarında kullanımı idealdir.

Beyaz,Antrasit Gri ve ,Eloksal olmak üzere 3 renk çeşidi mevcuttur.

It is generally used in door screens. It prevents the feet from being stuck in places where there is a lot of human exit. It does not deform due to its hard feature, it provides a long use. It is used in general usage area garden and terrace exits. There are 3 types as White, Anthracite Gray and Anodized

There are 3 types available as White, Anthracite Gray and Anodized

CORNER TENSIONER, SET CONTENT

SIRA NO		
1	Kasa	Till
2	Kanat	Wing
3	Tül	Mesh
4	Köşe Aksesuarı	Corner Accessory
5	Rulman Aksesuarı	Bearing Accessory
6	Gergi İpi	Tension Rope
7	Kıl Fıtlı	Weather Strip
8	PVC Şerit	PVC Strip
9	Montaj Kapağı	Mounting Cover
10	Kuş Gözü	Eyelet



27 MM PENCERE
27 MM WINDOW



27 MM KAPI
27 MM DOOR



27 MM DUBLE PENCERE
27 MM DOUBLE WINDOW



27 MM EŞİKSİZ KAPI
27 MM NON-THRESHOLD DOOR





DUBLE KAPI
DOUBLE DOOR



27 MM GEZER SİNEKLİK
27 MM PORTABLE FLY SCREEN



DUBLE EŞİKSİZ KAPI
NON-THRESHOLD DOUBLE DOOR



27 MM EŞİKSİZ GEZER SİNEKLİK
27 MM NON-THRESHOLD PORTABLE FLY SCREEN





18 MM SERİ ÜRÜN BİLEŞENLERİ
18 MM SERIES PRODUCT COMPONENTS

FLY SCREEN SYSTEMS

18mm - NORMAL / 18mm - EŞİKLİ
18mm NORMAL / 18mm WITH THRESHOLD

02

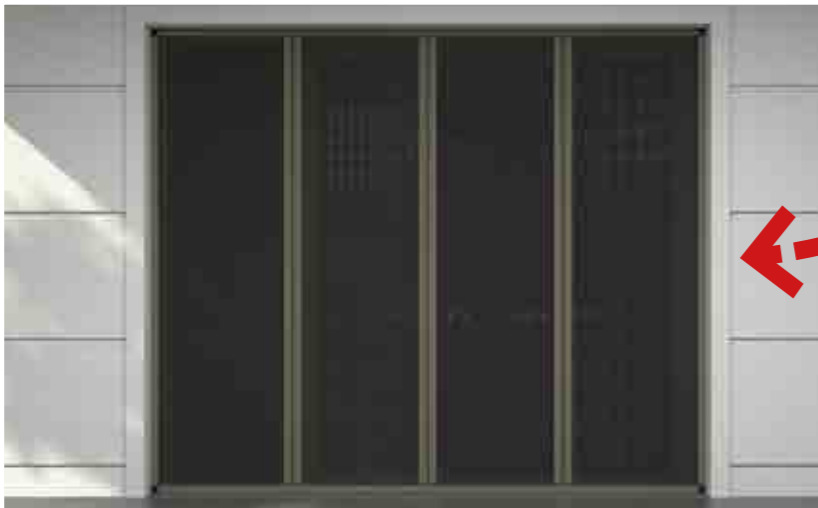
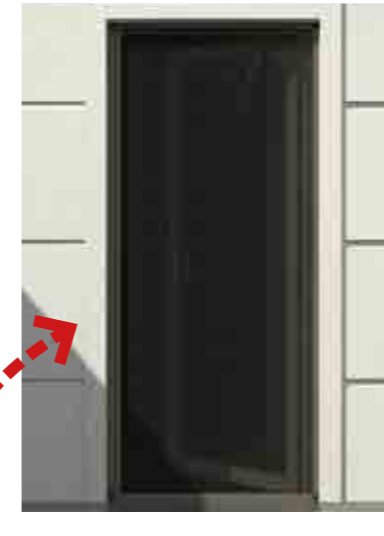

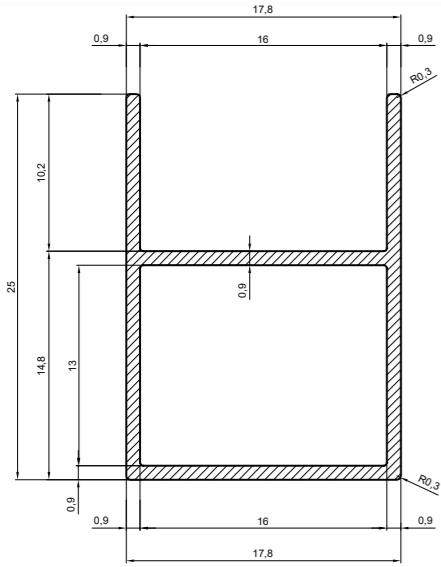
18 MM KASA PROFİLİ
18 MM CASE PROFILE

Alüminyum ekstrüzyon sıcak olarak yapılır. Üretim sırasında 6063 serisi biletler kullanılır. Biletler 420-520°C'de ısıtılır, kalıplar 450°C ısıtılmış olmalıdır ve presten çıkan profilin sıcaklığı 500°C nin üzerindedir. Ekstrüzyondan çıkan profil soğutulur, soğuk germe işlemi yapılır ve istenen boyda kesilir. Daha sonra ısıtma işlemi uygulanarak profillere mukavemet kazandırılır. Bu işlem esnasında profiller 185°C'de 5 saat tutulur. Mukavemet kazanan profiller müşteri talebine göre toz boya hattına, eloksal hattına, ahşap transfer hattına veyahut mekanik işlem hattına gider. Uygulanan gerekli işlemler sonrası profiller sevke hazır hale gelir.

Kasa profili: 18 mm derinlik 25 mm ön yüzey genişliğiyle tok bir görünüm sağlar. Plise sinekliğin ana profili diyebiliriz. Köşe takozlarının birleştirilmesiyle plise sinekliğin iskeletini oluşturur diyebiliriz.

It is produced in an aluminum extrusion mold. 6063 series billets are used during production. Billets are heated at 420-520°C, molds

It must be heated to 450°C and the temperature of the profile coming out of the press is above 500°C. The profile coming out of the extrusion is cooled, cold stretching is performed and cut to the desired length. Then, the profiles are strengthened by applying heat treatment. During this process

Profiles are kept at 185°C for 5 hours. Profiles that gain strength can be applied to powder coating line, anodized line, wooden goes to the transfer line or mechanical processing line. After the necessary processes are applied, the profiles are ready for shipment.

The case profile provides a solid appearance With a depth of 18 mm and a front surface width of 25 mm. We can call this profile the main profile of "Plisse Polyester Mesh, Fly Screen". By combining the corner wedges, the skeleton of the pleated mosquito net is formed.

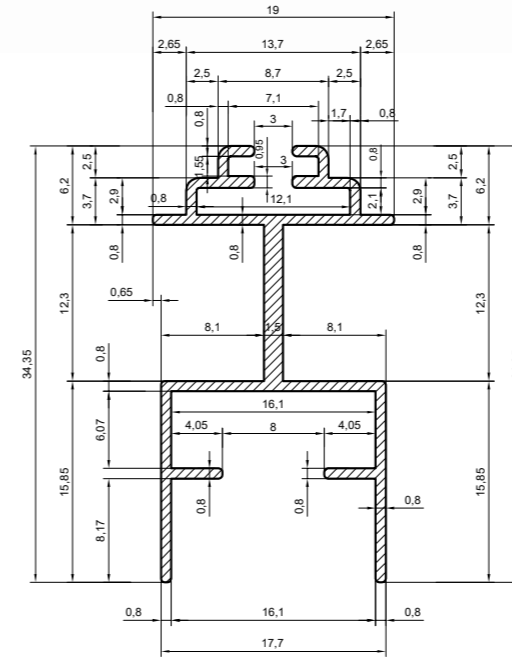
18 MM KANAT PROFİLİ
18 MM WING PROFILE

Kanat Profili: Kasa profiliyle uyumlu baş kısımlarına takılan teker aksesuarları sayesinde plise tülün hareket etmesini sağlayan profildir. Özel dizaynıyla tülü içine hapsederek tülün uzun ömürlü olmasını sağlar.

Wing Profile: It is the profile that allows the plisse polyester mesh to move owing to the wheel accessories attached to the head parts compatible with the frame profile. With its special design, it ensures that the plisse polyester mesh is long-lasting by trapping the mesh inside.

TÜL :14 ve 15 MM
TULLE: 14 AND 15 MM

ŞERİT 15 MM
STRIP 15 MM

ÜRÜN TEKNİK AÇIKLAMASI

ÜRÜN ADI	Özel tasarım polyester file
DOKUMA YAPISI	Pileli
RENK	Gri-Siyah
İPLİK ÇAPI (MM) Çözgü :	0.3+/-0.02mm atk:0.3+/- 0.02mm
BİTİŞ YOĞUNLUĞU (ENDS/İNÇ) Çözgü	18 atk : 16
ALAN AĞIRLIĞI (G/M2)	70 g/m2 :+/-5 g/m2
BİLEŞİM	Polyester
KIRMA KUVVETİ (N/25MM) Çözgü:	>180 atk: >160
STANDART İLE (M)	2m / 2.2m/ 2.4m /2.7m/ 3m'den itibaren
STANDART PARÇA UZUNLUĞU (M)	26m'den itibaren:+/- 1m
DAYANIKLILIK ISI	-10 derece /+50 derece
PARÇA UZUNLUĞU (PC)	Talep üzerine temin edilebilir

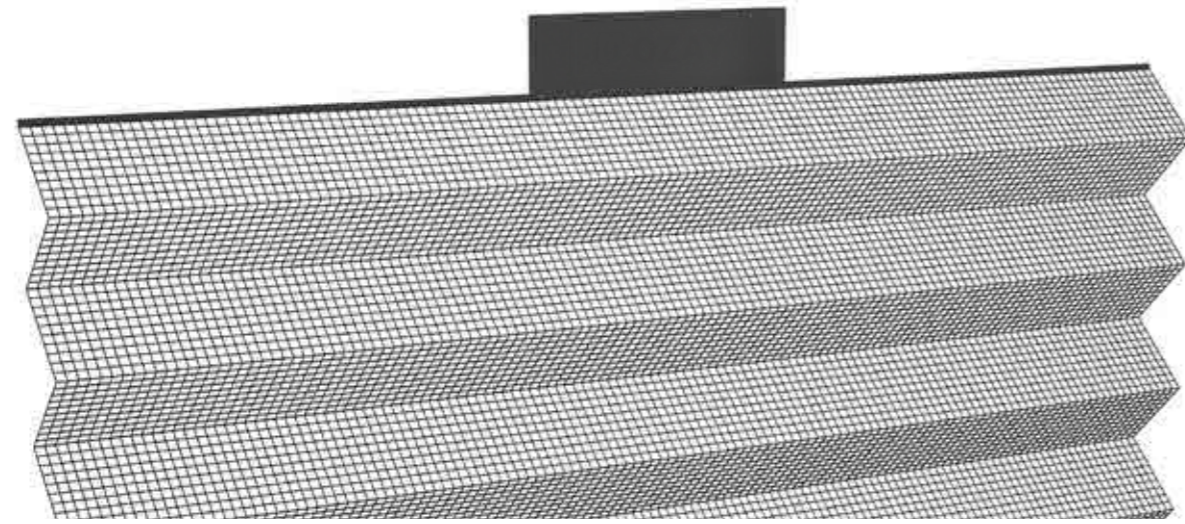

Plise Sineklik Pvc Bantlı Şerit sinekliğin tülüne yapıştırılarak tül ile alüminyum bağlantısını sağlamaktadır. Bu ürünün en büyük özelliği ısıya karşı dayanıklı Pvc malzemeden üretilmesidir. Üzerindeki çift taraflı bant dış hava şartlarında, sıcakta ve soğukta özelliğini yitirmemelidir. Pvc Şeritler üretildikten sonra firmamız tarafından sıcak hava şartlarında dayanımı kontrol edilmekte ve bu ürün için özel üretilen bantlar yapıştırılmaktadır. **AK PLİSE** markalı Pvc Şeritlerin **10 yıl garanti** süresi vardır

Plise Fly Screen Pvc Taped Strip is attached to the tulle of the fly screen and provides the aluminum connection with the tulle. The biggest feature of this product is that it is produced from heat resistant PVC material. The double-sided tape on it does not lose its exterior, hot and cold properties. After the PVC Strips are produced, their strength is checked by our company in hot weather conditions and the tapes specially produced for this product are adhered. AK PLİSE branded PVC Strips have a warranty period of 10 years.

İP
ROPE



CORNER TENSIONER, SET CONTENT

PRODUCT NAME	Special design polyester mesh
WOVEN STRUCTURE	Pleated
COLOR	Gray - Black
YARN DIAMETER (MM)	Warp : 0,3+/-0,02mm weft:0,3+/- 0,02mm
ENDS DENSITY (ENDS/INCH)	Warp : 18 weft : 16
AREA WEIGHT (G/M2)	70 g/m2 :+/-5 g/m2
COMPOSITION	Polyester
BREAKING STRENGTH (N/25MM)	Warp: >180
STANDARD WITH (M)	From 2m / 2,2m/ 2,4m /2,7m/ 3m
STANDARD PIECE LENGTH (M)	From 26m:+/- 1m
ENDURANCE HEAT	-10 degree /+50 degree
PIECES LENGTH (PC)	Available upon request

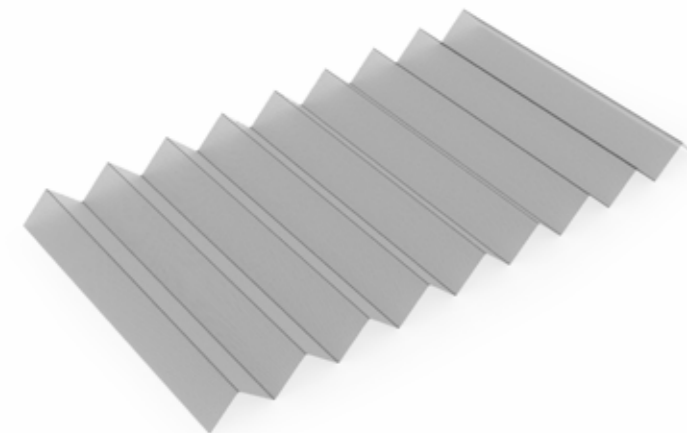

Sineklik sistemlerinin en önemli bileşenlerinden biri olan sineklik ipleri mekanizmanın sorunsuz çalışabilmesi için pek çok bitirme işleminden geçirilmektedir.

Kullanım sırasında tül sisteminin formunun bozulmasını engellemek için ısı işleminden geçirilmekte uzaması azaltılmakta ve sürtünme dayanımı artırılmaktadır.

Fly screen ropes, one of the most important components of mosquito net systems, are subjected to many finishing processes in order for the mechanism to work smoothly. In order to prevent the form of the tulle system from deteriorating during use, it is heat treated and elongated. is reduced and frictional resistance is increased.

KASA VE KANAT BİLEŞENLERİ

CASE AND WING COMPONENTS

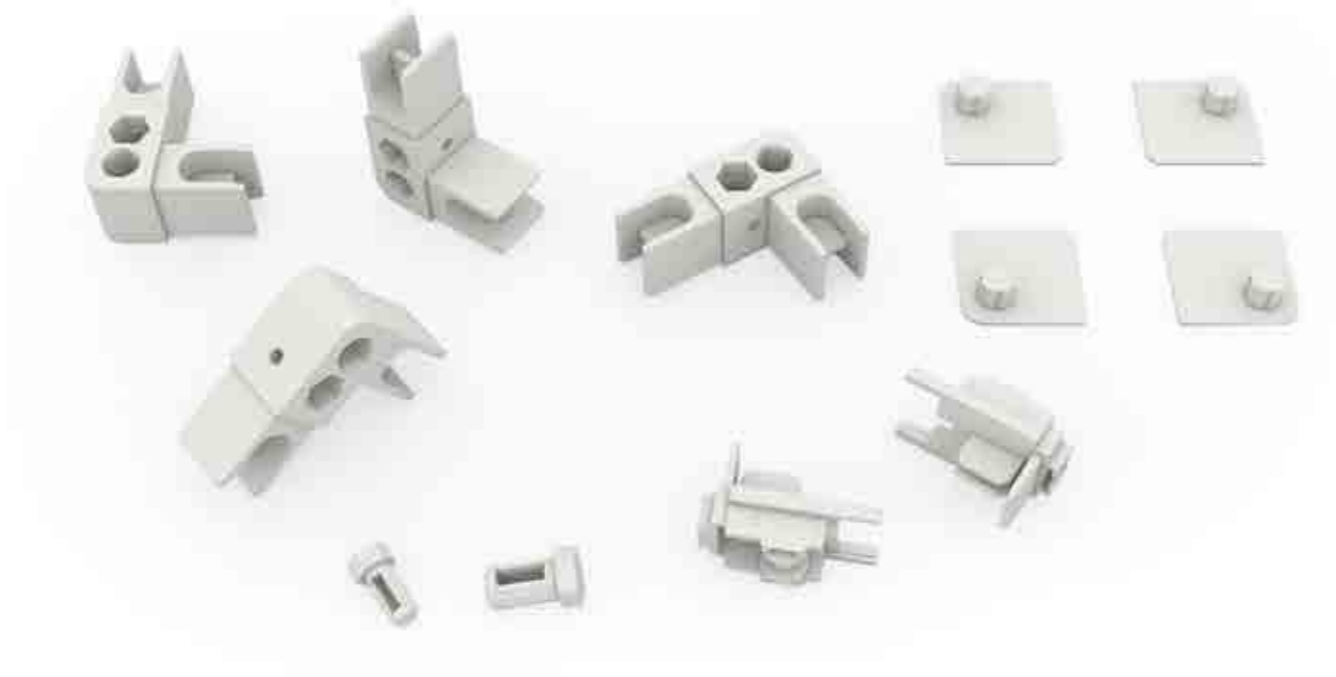

18 MM AKSESUAR SİSTEMLERİ

18 MM ACCESSORY SYSTEMS

Köşe Takozu / Corner Wedge

Yatay ve Dikey Kasa profil kesitlerinin birleşmesinde kullanılan orijinal moblen hammadde ile üretilmektedir.

It is produced with the original moblen raw material used in the union of the Horizontal and Vertical Frame profile sections.

Rulman Teker / Bearing Wheel

Sistemde Yatay ve Dikey olarak kullanılan kanat profilinin baş kısımlarında kullanılmaktadır. İçerisinde bulundurduğu derlin hammadde ve demir pim sistemi sayesinde kolay açılıp kapanmaya yarayan plastik enjeksiyon ürünüdür.

It is used in the head parts of the wing profile, which is used horizontally and vertically in the system. It is a plastic injection product for easy opening and closing thanks to the deep raw material it contains and the iron pin system.

Pim Birleşimi / Pin Joint

Dikey ve yatay profillerin birleşiminde kullanılan köşe takozunun merkez noktasından geçen plise sineklik kord ip'in geçişinde kullanılan çevresinde kullanılan dikey çıkıntılar sayesinde sıkıştırmasını sağlayan kitleme pimi özel baskı tekniği ve orijinal hammadde kullanılarak yapılan plastik enjeksiyon ürünüdür.

The pleated fly screen passing through the center point of the corner wedge used in the union of the vertical and horizontal profiles, the locking pin used in the passage of the rope and used around it, which enables it to be compressed thanks to the vertical protrusions, is a plastic injection product made using the special printing technique and original raw material.

Köşe Kapakları / Corner Covers

Montaj bitiminde köşe aksesuarlarının vida deliklerinin kapatılmasında kullanılır ve estetik bir görünüm sağlar.

It is used to close the screw holes of the corner accessories at the end of the assembly and provides an aesthetic appearance.



KASA VE KANAT BİLEŞENLERİ CASE AND WING JOINT COMPONENTS

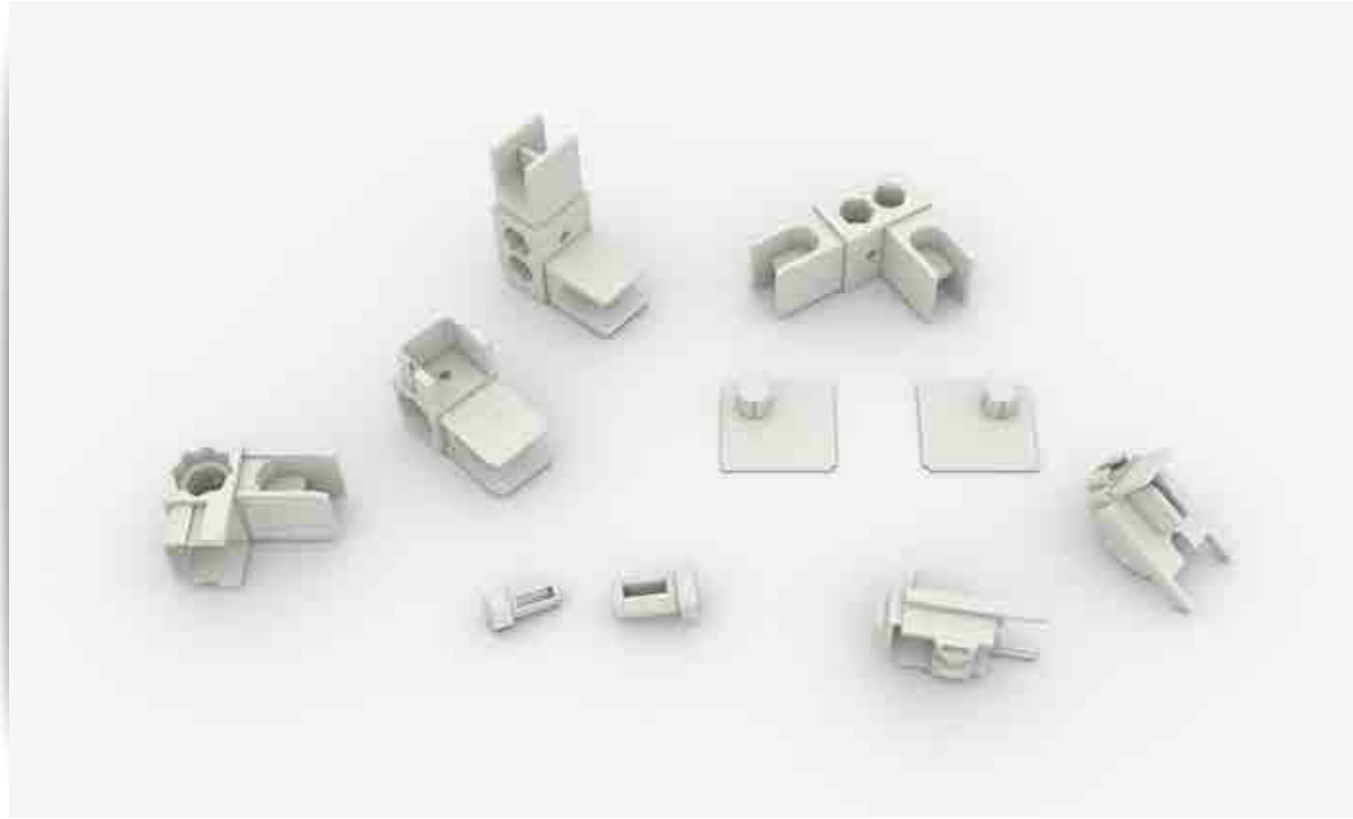

EŞİKSİZ PROFİL NON-THRESHOLD PROFILE

Genellikle kapı sinekliklerinde kullanılır. İnsan çıkışının çok olduğu yerlerde ayak takılmasını engeller sert özelliğinden dolayı deforme olmaz, uzun bir kullanım sağlar. Genel kullanım alanı bahçe, teras çıkışlarında kullanımı idealdir.

Beyaz, Antrasit Gri ve ,Eloksal olmak üzere 3 renk çeşidi mevcuttur.

It is generally used in door screens. It prevents the feet from being stuck in places where there is a lot of human exit. It does not deform due to its hard feature, it provides a long use. It is used in general usage area garden and terrace exits. There are 3 types as White, Anthracite Gray and Anodized

There are 3 types available as White, Anthracite Gray and Anodized



Köşe Takozu / Corner Wedge

Yatay ve Dikey Kasa profil kesitlerinin birleşmesinde kullanılan orijinal moblen hammadde ile üretilmektedir.

It is produced with the original moblen raw material used in the union of the Horizontal and Vertical Frame profile sections.



Rulman Teker / Bearing Wheel

Sistemde Yatay ve Dikey olarak kullanılan kanat profilinin baş kısımlarında kullanılmaktadır. İçerisinde bulundurduğu derlin hammadde ve demir pim sistemi sayesinde kolay açılıp kapanmaya yarayan plastik enjeksiyon ürünüdür.

It is used in the head parts of the wing profile, which is used horizontally and vertically in the system. It is a plastic injection product for easy opening and closing thanks to the deep raw material it contains and the iron pin system



Pim Birleşimi / Pin Joint

Dikey ve yatay profillerin birleşiminde kullanılan köşe takozunun merkez noktasından geçen plise sineklik kord ip'in geçişinde kullanılan çevresinde kullanılan dikey çıkıntılar sayesinde sıkıştırmasını sağlayan kitleme pimi özel baskı tekniği ve orijinal hammadde kullanılarak yapılan plastik enjeksiyon ürünüdür.

The pleated fly screen passing through the center point of the corner wedge used in the union of the vertical and horizontal profiles, the locking pin used in the passage of the rope and used around it, which enables it to be compressed thanks to the vertical protrusions, is a plastic injection product made using the special printing technique and original raw material

Köşe Kapakları / Corner Covers

Montaj bitiminde köşe aksesuarlarının vida deliklerinin kapatılmasında kullanılır ve estetik bir görünüm sağlar.

It is used to close the screw holes of the corner accessories at the end of the assembly and provides an aesthetic appearance.



KIL FITİLİ WEATHER STRIP

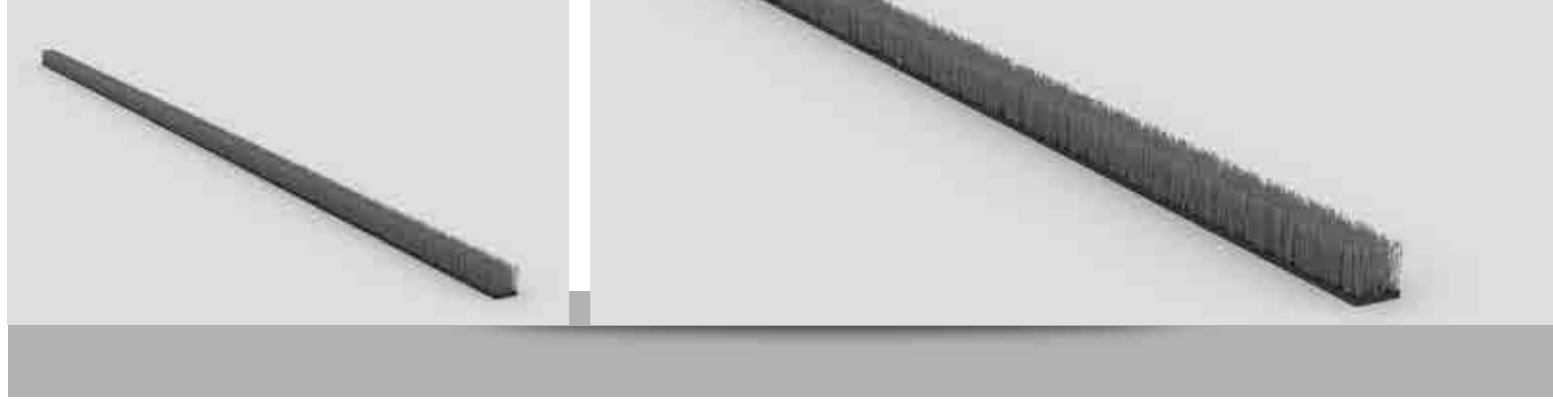

Standart kapi ve pencere sinekliklerinde kullanılan kanat profillerinin mıknatis kısmı için kullanılan özel boşluğun kapatılmasında kullanılır. Çok önemli özelliği olmamakla birlikte estetik açısından güzel bir görünüm sağlar ve kısmen sineklikte oluşabilecek tozlanmayı ve kirlenmeyi önler.

It is used to close the special space used for the magnetic part of the sash profiles used in standard door and window fly screens. Although it is not a very important feature, it provides a beautiful appearance in terms of aesthetics and is partially in the mosquito net. It prevent dusting and contamination that may occur.

MIKNATIS STRAIGHT MAGNET AND TRIANGLE MAGNET

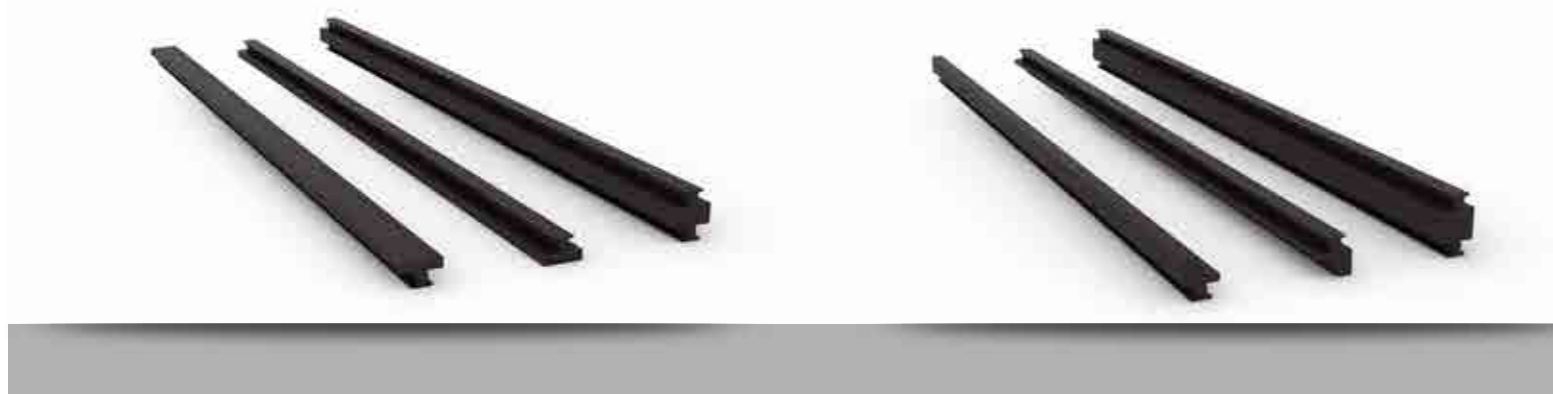

Düz ve üçgen mıknatis; belli bir standartın üstündeki ölçülerde sistemin sağlıklı çalışabilmesi adına bir takım değişiklikler yapılır.Önemli detaylardan birisi büyük ölçülerde kullandığımızı duble sistemdir,daha kolay bir kullanım sağlar, çift taraflı kanat kullanılır.Mıknatis iki kanadın birleşiminde kullanılır.Kanat Profilinin özel kanalına takılarak sistemin çalışmasını sağlar,düz ve üçgen mıknatis tercih sebebidir,üçgen mıknatisin bir özelliği üretim sırasında oluşabilecek sistemin çalışmasını engellemeyecek ufak hataların giderilmesinde önemlidir.

Flat and triangular magnets; in measurements above a certain standard, some changes are made in order for the system to work healthily. One of the important details is the double system we use in large sizes, it provides an easier use and double-sided wing is used. It allows it to work. Flat and triangular magnets are preferred, the triangular magnet feature does not prevent the system from working during production and allows minor errors to be eliminated.

KUŞ GÖZÜ EYELET



Plise sinekliğin ip'in geçişinde kullanılan sineklik ve perde ürünlerinde kullanabileceğiniz metal özel kaplamalı kuşgözü kapsül. Bu ürünü tulumba presinde ve otomatik makinalarda delici ve çakma kalıpları kullanarak uygulayabilirsiniz. Ürün sac malzemedir yapılmış, ve alüminyum kaplamadır.

It is a metal specially coated capsule that you can use in fly screen systems and curtain products used in the passage of pleated fly screen systems. You can apply this product in pump presses and automatic machines by using piercing and hammering dies. The product is made of sheet material and has an aluminum coating.

MANTAR BAŞLIK VİDA CORK HEAD SCREW



Mantar başlı üretim vidası; Şerite yapıştırılan tülün kasa profiline sabitlemesinde kullanılır,en önemli özelliği geniş başlı olması sebebiyle tülün yırtılmasına engel olur ve güçlü bir mukavemet sağlar.

Cork Head Screw, is used to fix the plisse polyester mesh attached to the strip, to the frame profile. The most important feature, owing to its wide head, prevents the polyester mesh from tearing and provides a strong strength.

/// EŞİKSİZ 18 MM NORMAL
NON-THRESHOLD 18 MM NORMAL

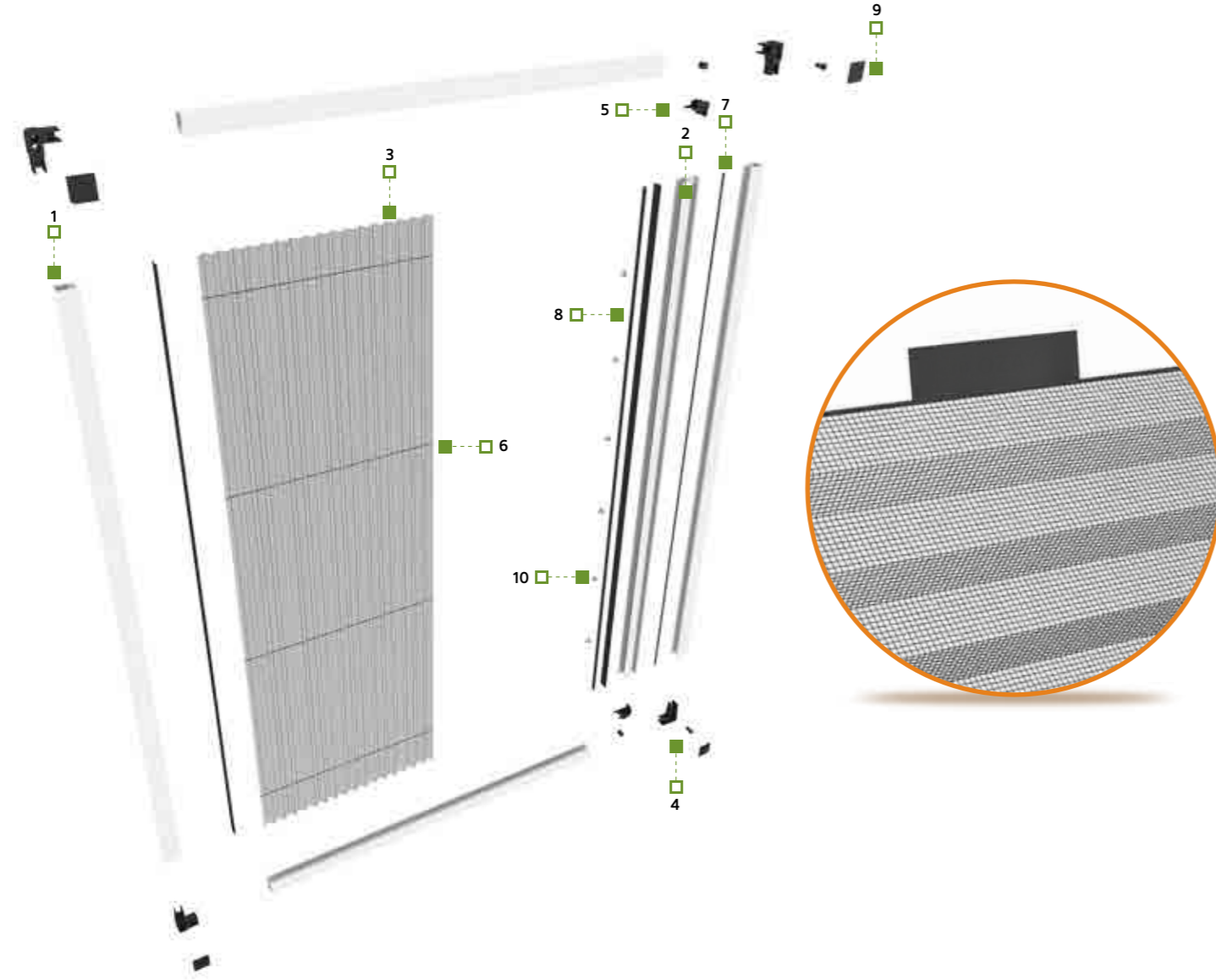

/// EŞİKSİZ 18 MM ESİKSİZ
NON-THRESHOLD 18 MM

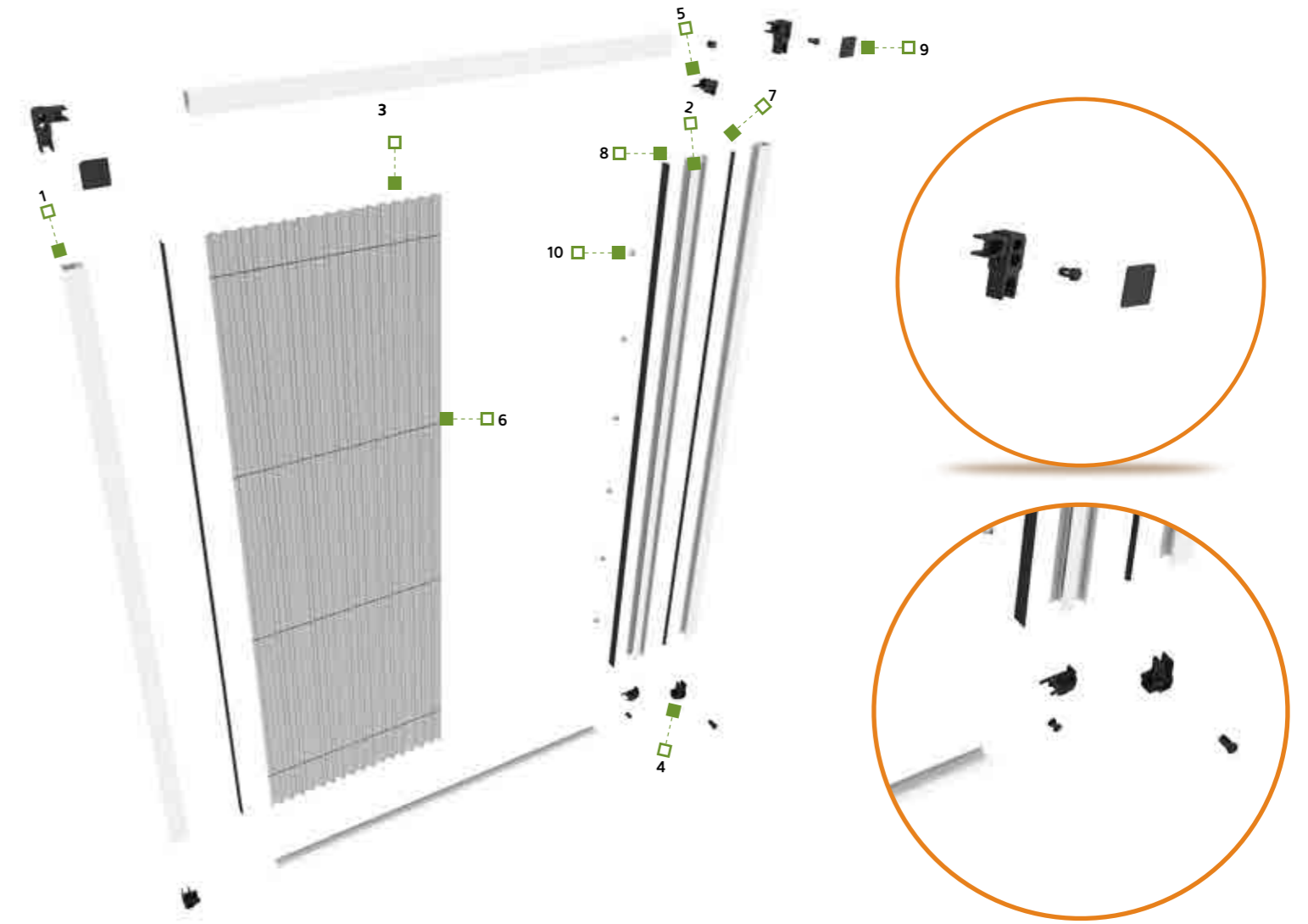

/// Bu serinin en önemli özelliği montaj esnasında montaj yerinin kısıtlı olması durumunda çözüm odaklı seridir. En uygun kullanım Alanı panjurlu doğrama ve pencerelerdir. Gramaj anlamında ekonomiktir.

/// It is a very preferred series especially for doors, the tulle net is on one side or on each side. It can be folded into the case on both sides. Pleated case, aluminum frame profile and door or window sill, corner directly with the help of screws through the mounting holes in the easily fixed

KÖŞEDEN GERGI SET İÇERİĞİ

SIRA NO		
1	Kasa	Till
2	Kanat	Wing
3	Tül	Mesh
4	Köşe Aksesuarı	Corner Accessory
5	Rulman Aksesuarı	Bearing Accessory
6	Gergi İpi	Tension Rope
7	Kıl Fıtlı	Bristle Wick
8	PVC Şerit	PVC Strip
9	Montaj Kapağı	Mounting Cover

/// Genellikle kapı sinekliklerinde kullanılır. İnsan çıkışının çok olduğu yerlerde ayak takılmasını engeller sert özelliğinden dolayı deforme olmaz, uzun bir kullanım sağlar. Genel kullanım alanı bahçe, teras çıkışlarında kullanımı idealdir.

Beyaz,Antrasit Gri ve ,Eloksal olmak üzere 3 renk çeşidi mevcuttur.

/// It is generally used in door screens. It prevents the feet from being stuck in places where there is a lot of human exit. It does not deform due to its hard feature, it provides a long use. It is used in general usage area garden and terrace exits. There are 3 types as White, Anthracite Gray and Anodized

There are 3 types available as White, Anthracite Gray and Anodized

CORNER TENSIONER, SET CONTENT

SIRA NO		
1	Kasa	Till
2	Kanat	Wing
3	Tül	Mesh
4	Köşe Aksesuarı	Corner Accessory
5	Rulman Aksesuarı	Bearing Accessory
6	Gergi İpi	Tension Rope
7	Kıl Fıtlı	Weather Strip
8	PVC Şerit	PVC Strip
9	Montaj Kapağı	Mounting Cover
10	Kuş Gözü	Eyelet



18 MM PENCERE
18 MM WINDOW



18 MM KAPI
18 MM DOOR



18 MM DUBLE PENCERE
18 MM DOUBLE WINDOW



18 MM EŞİKSİZ KAPI
18 MM NON-THRESHOLD DOOR





DUBLE KAPI
DOUBLE DOOR



DUBLE EŞİKSİZ KAPI
NON-THRESHOLD DOUBLE DOOR





18 MM İÇTEN TAKMA SERİ
18 MM INTERIOR-MOUNTED SERIES

FLY SCREEN SYSTEMS
18mm - NORMAL / 18mm - WITH THRESHOLD

03

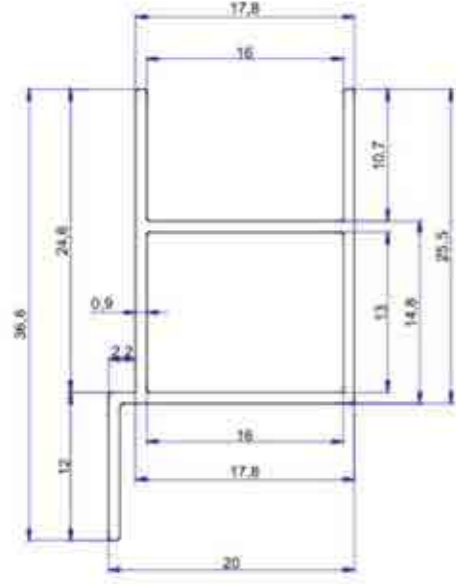

18 MM İÇTEN TAKMA KASA PROFİLİ
18 MM INTERIOR-MOUNTED CASE PROFILE

Alüminyum ekstrüzyon sıcak olarak yapılır. Üretim sırasında 6063 serisi biletler kullanılır. Biletler 420-520°C'de ısıtılır, kalıplar 450°C ısıtılmış olmalıdır ve prestren çıkan profilin sıcaklığı 500°C nin üzerindedir. Ekstrüzyondan çıkan profil soğutulur, soğuk germe işlemi yapılır ve istenen boyda kesilir. Daha sonra ışıl işlem uygulanarak profillere mukavemet kazandırılır. Bu işlem esnasında profiller 185°C'de 5 saat tutulur. Mukavemet kazanan profiller müşteri talebine göre toz boya hattına, eloksal hattına, ahşap transfer hattına veyahut mekanik işlem hattına gider. Uygulanan gerekli işlemler sonrası profiller sevke hazır hale gelir.

İçten takma serimizin özelliği montaj esnasında herhangi bir vidalama işlemi olmamasıdır, montaj yerinin kısıtlı olduğu durumlarda kullanılan pratik bir yöntemdir, pencere kasası ile pencere kanadı arasına metal veya plastik klipslerle uygulanır. rahatlıkla sokup takılabilir. Pencere kanadının damlalıklı kanat olması durumunda uygulama yapılamaz. 18 mm serimizden farkı tırnaklı kasa ve dizaynına özel köşe kapakları ve orijinal klipsleri olmasıdır. Avrupa ülkelerinde çokca tercih edilen bir sistemdir.

It is produced in an aluminum extrusion mold. 6063 series billets are used during production. Billets are heated at 420-520°C, molds It must be heated to 450°C and the temperature of the profile coming out of the press is above 500°C. The profile coming out of the extrusion is cooled, cold stretching is performed and cut to the desired length. Then, the profiles are strengthened by applying heat treatment. During this process, profiles are kept at 185°C for 5 hours. Profiles that gain strength can be applied to powder coating line, anodized line, wooden goes to the transfer line or mechanical processing line. After the necessary processes are applied, the profiles are ready for shipment.

The feature of our Interior-Mounted series; no screwing is required during assembly. It is a practical method used in situations where the place to be mounted is limited.

It is attached between the window frame and the wing with metal or plastic clips. It can be easily removable. This application cannot be done if the window case is dropper. The difference from our 18 mm series is the use of special corner caps and original clips for the case design with claw. It is a system that is highly preferred in European countries.

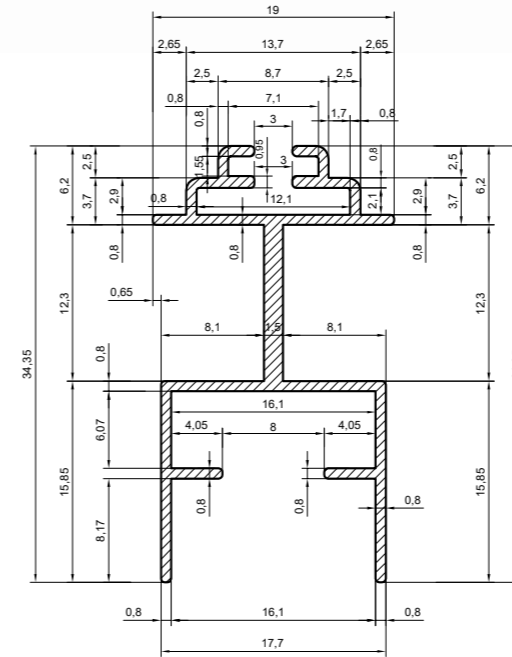
18 MM İÇTEN TAKMA KANAT PROFİLİ
18 MM INTERIOR-MOUNTED CASE PROFILE

Kanat Profili: Kasa profiliyle uyumlu baş kısımlarına takılan teker aksesuarları sayesinde plise tülün hareket etmesini sağlayan profildir. Özel dizaynıyla tülü içine hapsederek tülün uzun ömürlü olmasını sağlar.

Wing Profile: It is the profile that allows the plisse polyester mesh to move owing to the wheel accessories attached to the head parts compatible with the frame profile. With its special design, it ensures that the plisse polyester mesh is long-lasting by trapping the mesh inside.

TÜL :14 ve 15 MM
TULLE: 14 AND 15 MM

ŞERİT 15 MM
STRIP 15 MM

ÜRÜN TEKNİK AÇIKLAMASI

ÜRÜN ADI	Özel tasarım polyester file
DOKUMA YAPISI	Pileli
RENK	Gri-Siyah
İPLİK ÇAPI (MM) Çözüğü :	0.3+/-0.02mm atkı:0.3+/- 0.02mm
BİTİŞ YOĞUNLUĞU (ENDS/İNÇ) Çözüğü	18 atkı : 16
ALAN AĞIRLIĞI (G/M2)	70 g/m2 :+/-5 g/m2
BİLEŞİM	Polyester
KIRMA KUVVETİ (N/25MM) Çözüğü:	>180 atkı: >160
STANDART İLE (M)	2m / 2.2m/ 2.4m /2.7m/ 3m'den itibaren
STANDART PARÇA UZUNLUĞU (M)	26m'den itibaren:+/- 1m
DAYANIKLILIK ISI	-10 derece /+50 derece
PARÇA UZUNLUĞU (PC)	Talep üzerine temin edilebilir

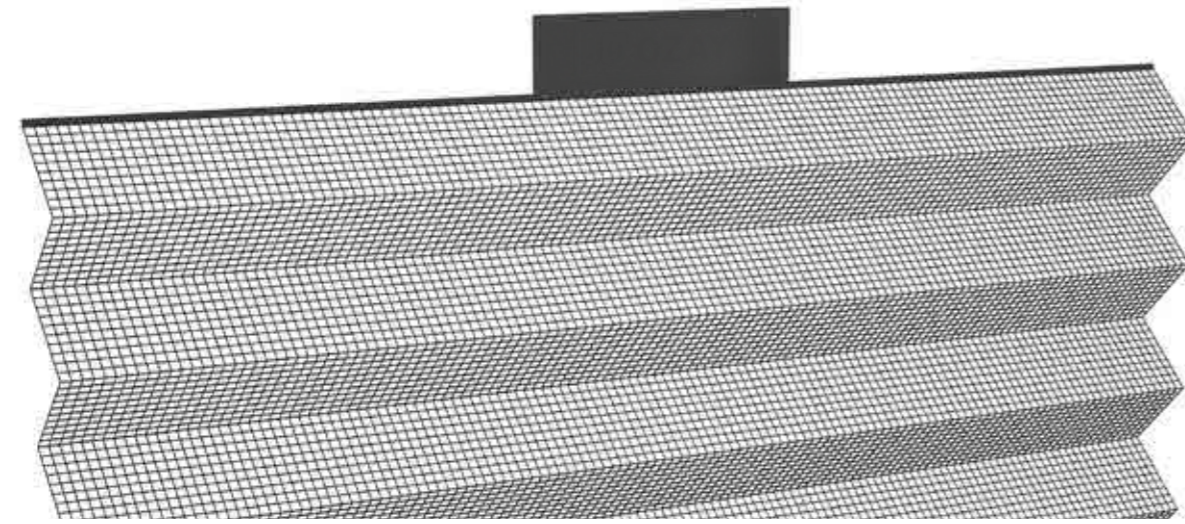

Plise Sineklik Pvc Bantlı Şerit sinekliğin tülüne yapıştırılarak tül ile alüminyum bağlantısını sağlamaktadır. Bu ürünün en büyük özelliği ısıya karşı dayanıklı Pvc malzemeden üretilmesidir. Üzerindeki çift taraflı bant dış hava şartlarında, sıcakta ve soğukta özelliğini yitirmemelidir. Pvc Şeritler üretildikten sonra firmamız tarafından sıcak hava şartlarında dayanımı kontrol edilmekte ve bu ürün için özel üretilen bantlar yapıştırılmaktadır. **AK PLİSE** markalı Pvc Şeritlerin **10 yıl garanti süresi** vardır

Plise Fly Screen Pvc Taped Strip is attached to the tulle of the fly screen and provides the aluminum connection with the tulle. The biggest feature of this product is that it is produced from heat resistant PVC material. The double-sided tape on it does not lose its exterior, hot and cold properties. After the PVC Strips are produced, their strength is checked by our company in hot weather conditions and the tapes specially produced for this product are adhered. AK PLİSE branded PVC Strips have a warranty period of 10 years.

İP
ROPE



PRODUCT TECHNICAL DESCRIPTION

PRODUCT NAME	Special design polyester mesh
WOVEN STRUCTURE	Pleated
COLOR	Gray - Black
YARN DIAMETER (MM)	Warp : 0,3+/-0,02mm weft:0,3+/- 0,02mm
ENDS DENSITY (ENDS/INCH)	Warp : 18 weft : 16
AREA WEIGHT (G/M2)	70 g/m2 :+/-5 g/m2
COMPOSITION	Polyester
BREAKING STRENGTH (N/25MM)	Warp: >180 Weft : >160
STANDARD WITH (M)	From 2m / 2,2m/ 2,4m /2,7m/ 3m
STANDARD PIECE LENGTH (M)	From 26m:+/- 1m
ENDURANCE HEAT	-10 degree /+50 degree
PIECES LENGTH (PC)	Available upon request

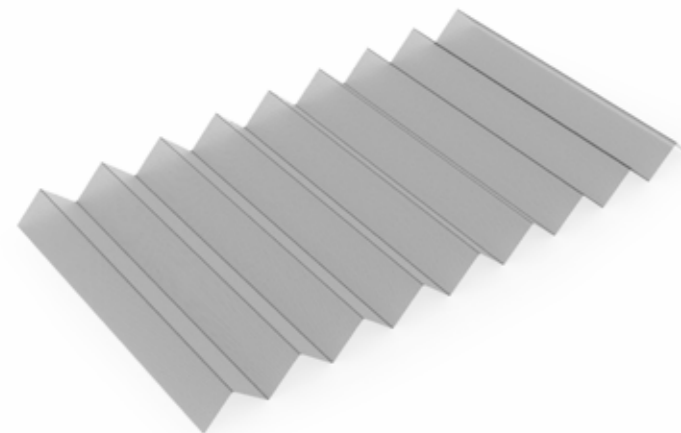

Sineklik sistemlerinin en önemli bileşenlerinden biri olan sineklik ipleri mekanizmanın sorunsuz çalışabilmesi için pek çok bitirme işleminden geçirilmektedir.

Kullanım sırasında tül sisteminin formunun bozulmasını engellemek için ısı işleminden geçirilmekte uzaması azaltılmakta ve sürtünme dayanımı artırılmaktadır.

Fly screen ropes, one of the most important components of mosquito net systems, are subjected to many finishing processes in order for the mechanism to work smoothly.

In order to prevent the form of the tulle system from deteriorating during use, it is heat treated and elongated. is reduced and frictional resistance is increased.



KASA VE KANAT BİLEŞENLERİ CASE AND WING JOINT COMPONENTS



İÇTEN TAKMA AKSESUAR SETİ INTERIOR-MOUNTED ACCESSORY SET

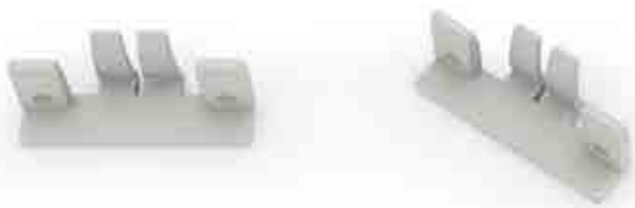

Klips / Clips

Pencere kasası ile pencere kanadın da kullanılan rahatlıkla sökülüp takıla bilen plastik enjeksiyon ürünüdür.

It is a plastic injection part that can be used in the window frame and window frame which is easy removable.

Köşe Takoğu / Corner Wedge

Yatay ve Dikey Kasa profil kesitlerinin birleşmesinde kullanılan orijinal moblen hammadde ile üretilmektedir.

It is produced with the original moblen raw material used in the union of the Horizontal and Vertical Frame profile sections.

Rulman Teker / Bearing Wheel

Sistemde Yatay ve Dikey olarak kullanılan kanat profilinin baş kısımlarında kullanılmaktadır. İçerisinde bulundurduğu derlin hammadde ve demir pim sistemi sayesinde kolay açılıp kapanmaya yarayan plastik enjeksiyon ürünüdür.

It is used in the head parts of the wing profile, which is used horizontally and vertically in the system. It is a plastic injection product for easy opening and closing thanks to the deep raw material it contains and the iron pin system

Pim Birleşimi / Pin Joint

Dikey ve yatay profillerin birleşiminde kullanılan köşe takoğunun merkez noktasından geçen plise sineklik kord ip'in geçişinde kullanılan çevresinde kullanılan dikey çıkıntılar sayesinde sıkıştırmasını sağlayan kitleme pimi özel baskı tekniği ve orijinal hammadde kullanılarak yapılan plastik enjeksiyon ürünüdür.

The pleated fly screen passing through the center point of the corner wedge used in the union of the vertical and horizontal profiles, the locking pin used in the passage of the rope and used around it, which enables it to be compressed thanks to the vertical protrusions, is a plastic injection product made using the special printing technique and original raw material

Köşe Kapakları / Corner Covers

Montaj bitiminde köşe aksesuarlarının vida deliklerinin kapatılmasında kullanılır ve estetik bir görünüm sağlar.

It is used to close the screw holes of the corner accessories at the end of the assembly and provides an aesthetic appearance.



KIL FITİLİ WEATHER STRIP

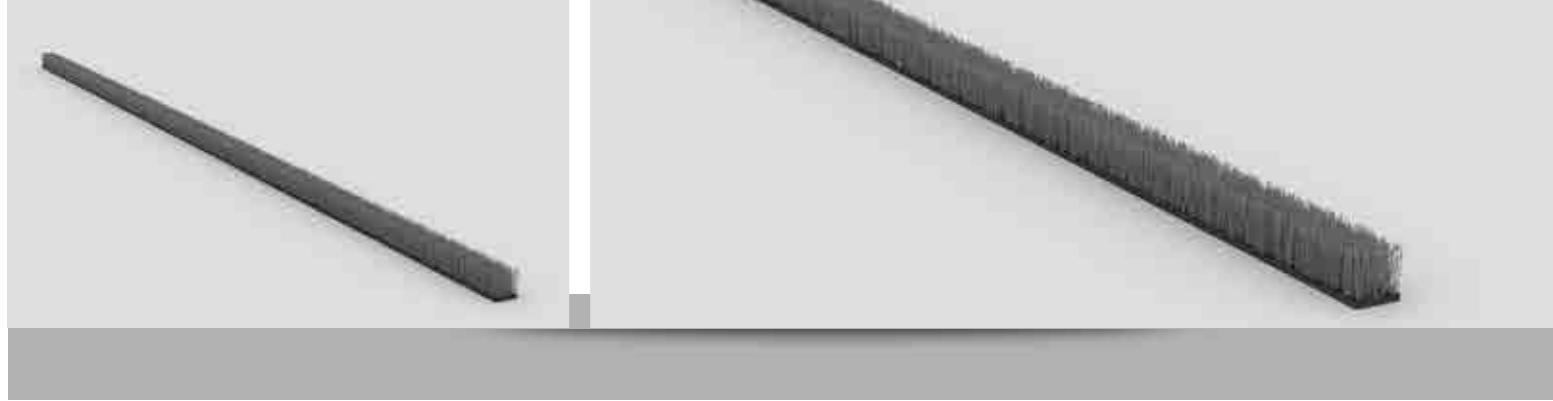

Standart kapi ve pencere sinekliklerinde kullanılan kanat profillerinin mıknatis kısmı için kullanılan özel boşluğun kapatılmasında kullanılır. Çok önemli özelliği olmamakla birlikte estetik açısından güzel bir görünüm sağlar ve kısmen sineklikte oluşabilecek tozlanmayı ve kirlenmeyi önler.

It is used to close the special space used for the magnetic part of the sash profiles used in standard door and window fly screens. Although it is not a very important feature, it provides a beautiful appearance in terms of aesthetics and is partially in the mosquito net. It prevent dusting and contamination that may occur.

MIKNATIS STRAIGHT MAGNET AND TRIANGLE MAGNET

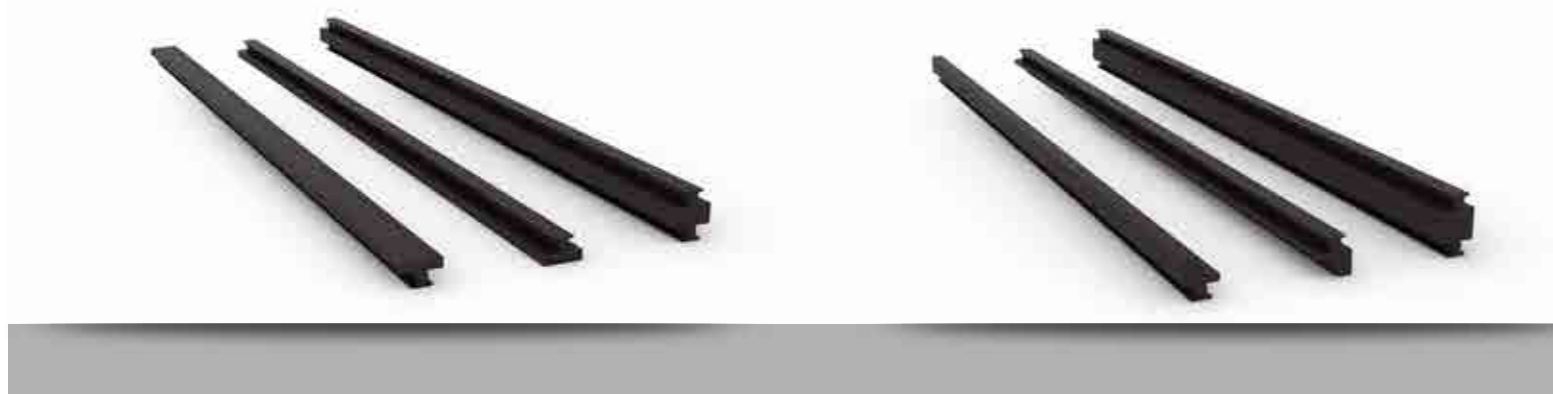

Düz ve üçgen mıknatis; belli bir standartın üstündeki ölçülerde sistemin sağlıklı çalışabilmesi adına bir takım değişiklikler yapılır.Önemli detaylardan birisi büyük ölçülerde kullandığımızı duble sistemdir,daha kolay bir kullanım sağlar, çift taraflı kanat kullanılır.Mıknatis iki kanadın birleşiminde kullanılır.Kanat Profilinin özel kanalına takılarak sistemin çalışmasını sağlar,düz ve üçgen mıknatis tercih sebebidir,üçgen mıknatisin bir özelliği üretim sırasında oluşabilecek sistemin çalışmasını engellemeyecek ufak hataların giderilmesinde önemlidir.

Flat and triangular magnets; in measurements above a certain standard, some changes are made in order for the system to work healthily. One of the important details is the double system we use in large sizes, it provides an easier use and double-sided wing is used. It allows it to work. Flat and triangular magnets are preferred, the triangular magnet feature does not prevent the system from working during production and allows minor errors to be eliminated.

KUŞ GÖZÜ EYELET



Plise sinekliğin ip'in geçişinde kullanılan sineklik ve perde ürünlerinde kullanabileceğiniz metal özel kaplamalı kuşgözü kapsül. Bu ürünü tulumba presinde ve otomatik makinalarda delici ve çakma kalıpları kullanarak uygulayabilirsiniz. Ürün sac malzemedir yapılmış, ve alüminyum kaplamadır.

It is a metal specially coated capsule that you can use in fly screen systems and curtain products used in the passage of pleated fly screen systems. You can apply this product in pump presses and automatic machines by using piercing and hammering dies. The product is made of sheet material and has an aluminum coating.

MANTAR VİDA CORK HEAD SCREW



Mantar başlı üretim vidası; Şerite yapıştırılan tülün kasa profiline sabitlemesinde kullanılır,en önemli özelliği geniş başlı olması sebebiyle tülün yırtılmasına engel olur ve güçlü bir mukavemet sağlar.

Cork Head Screw, is used to fix the plisse polyester mesh attached to the strip, to the frame profile. The most important feature, owing to its wide head, prevents the polyester mesh from tearing and provides a strong strength.

İÇTEN TAKMALI SABİT DELUXE

INTERIOR-MOUNTED FIXED DELUXE

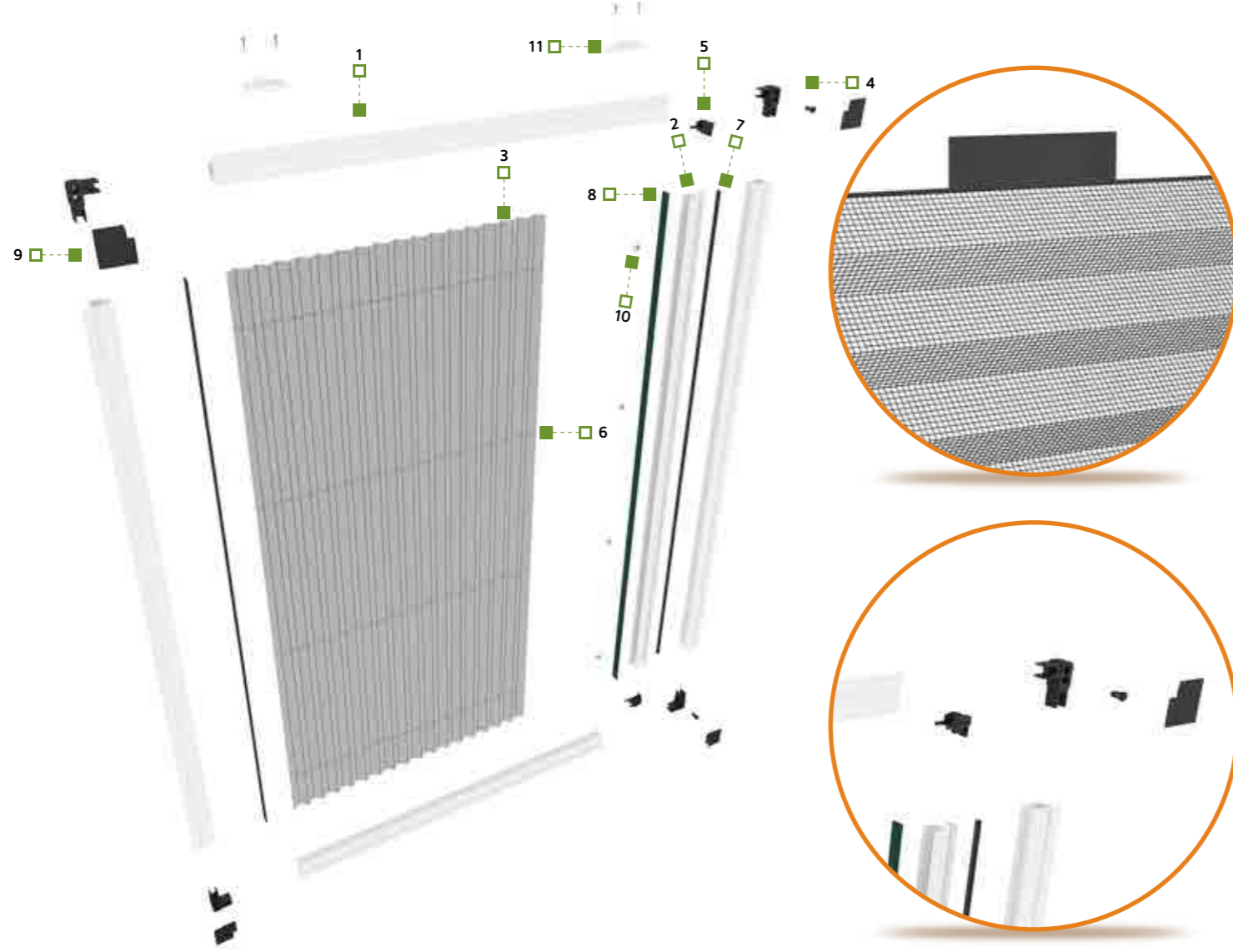

KÖŞEDEN GERGI SET İÇERİĞİ

SIRA NO		
1	Kasa	Till
2	Kanat	Wing
3	Tül	Mesh
4	Köşe Aksesuarı	Corner Accessory
5	Rulman Aksesuarı	Bearing Accessory
6	Gergi İpi	Tension Rope
7	Kıl Fitili	Weather Strip
8	PVC Şerit	PVC Strip
9	Montaj Kapağı	Mounting Cover
10	Kuş Gözü	Eyelet
11	Klips	Clips

İçten takma serimizin özelliği montaj esnasında herhangi bir vidalama işlemi olmamasıdır, montaj yerinin kısıtlı olduğu durumlarda kullanılan pratik bir yöntemdir, pencere kasası ile pencere kanadı arasında metal veya plastik klipslerle uygulanır. Rahatlıkla sokup takılabilir. Pencere kanadının damlalıklı kanat olması durumunda uygulama yapılamaz. 18 mm serimizden farki tırnaklı kasa ve dizaynına özel köşe kapakları ve orijinal klipsleri olmasıdır. Avrupa ülkelerinde çokça tercih edilen bir sistemdir.

The feature of our Interior-Mounted series; no screwing is required during assembly. It is a practical method used in situations where the place to be mounted is limited. It is attached between the window frame and the wing with metal or plastic clips. It can be easily removable. This application cannot be done if the window case is dropper. The difference from our 18 mm series is the use of special corner caps and original clips for the case design with claw. It is a system that is highly preferred in European countries.





18 MM PENCERE
18 MM WINDOW



18 MM KAPI
18 MM DOOR



18 MM DUBLE PENCERE
18 MM DOUBLE WINDOW



18 MM DUBLE KAPI
18 MM DOUBLE DOOR





17 x 25 SİNEKLİK SİSTEMİ

17 x 25 FLY SCREEN SYSTEM

04

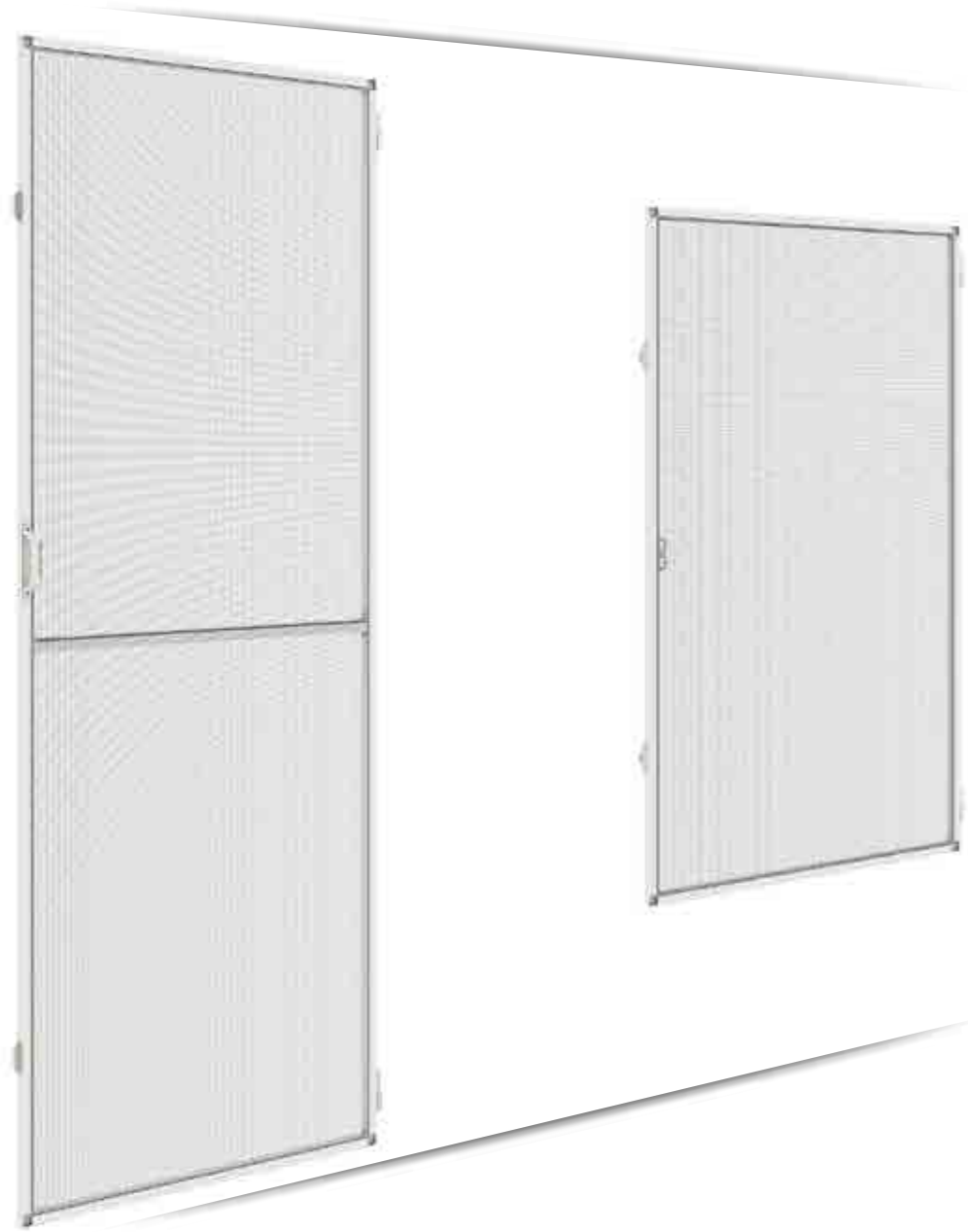

17x25 SİNEKLİK PROFİLİ

17 x 25 FLY SCREEN PROFILE

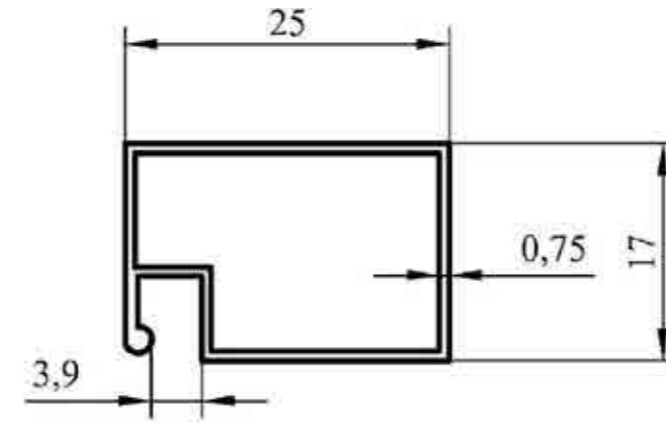

17x25 serimiz piyasada sabit sineklik diye adlandırılan serimizdir. Ekonomiktir. Menteşeli ve kulaklı olmak üzere iki çeşit üretim ve montajı yapılabilir. Düz tül kullanılır. Kapılarda ve büyük ölçülerde 20x40 ölçüsünde alüminyum profille kasa yapılabilir. Pileli sineklige göre daha az ömürlüdür,

Our 17x25 series is what is called fixed fly screen in the market. It is economical. It can be produced and assembled in two types, hinged and eared. Plain tulle is used. Frames can be made with 20x40 aluminum profiles on doors and large sizes and they have a longer life.



17 x 25 SİNEKLİK AKSESUARARI
17 x 25 FLY SCREEN ACCESSORIES



TUTAMAK / HOLDER

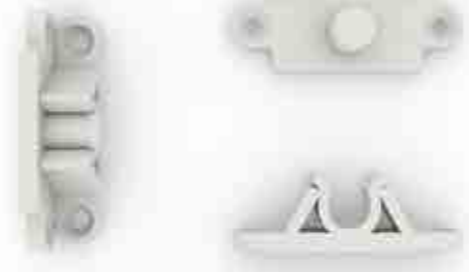

KAPI KİLİDİ / DOOR LOCK

17 x 25 SİNEKLİK AKSESUARARI
17 x 25 FLY SCREEN ACCESSORIES

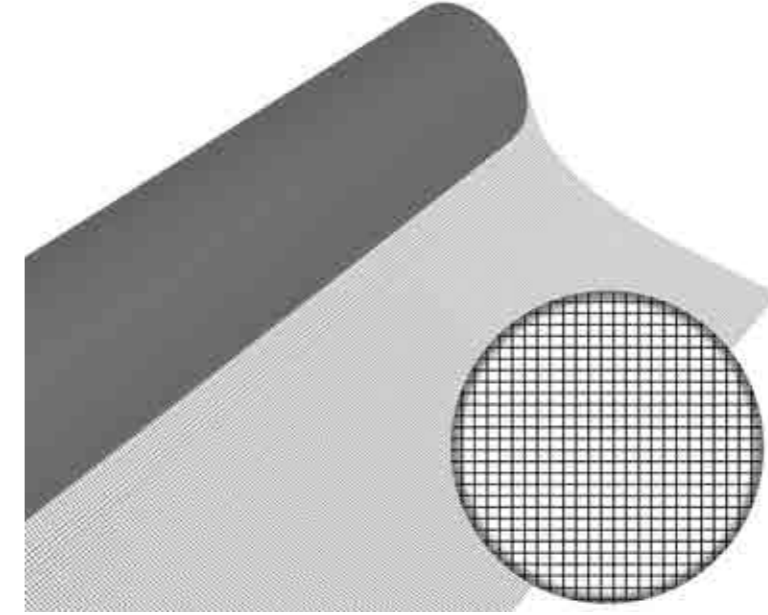

TÜL / MESH



MIKNATISLI PORT / MAGNETIC PORT



MENTEŞE / HINGE



KAYIT BAĞLANTI TAKOZU
CONNECTION WEDGE



TUTAMAK / HOLDER



CONTA / GASKET

PLİSE PERDE / PLISSE CURTAIN



Son yıllarda değişen hayat standartları insanların daha çok evde vakit geçirmelerine olanak sağlamıştır. Bu bağlamda insanlar yaşam alanlarını güzelleştirme ve daha konforlu bir hayat sürmek adına bir takım girişimlerde bulunmaktadır. En önemlilerinden birisi Plise Perde (Cam Balkon Perdesi)dir. Cam Balkon Perdesi denmesiyle beraber kullanım alanı çok daha fazladır. İki önemli özelliği vardır. Birincisi istenmeyen durumlarda güneş ışınlarını kesmesi, diğer önemli özelliği istenmeyen durumlarda görüntüyü kapatmasıdır. Değişik renk ve farklı kumaş seçenekleriyle mekanlara değişik bir atmosfer katmaktadır. AK Plise Firması zengin renk ve kumaş seçenekleriyle sektörün öncü kuruluşlarından birisi konumundadır. Bütün sistem ve bileşenleri kendi patentli ürünüdür.

PERDE SİSTEMLERİ / CURTAIN SYSTEMS

Changing living standards in recent years have allowed people to spend more time at home. Under these conditions, people are making a number of attempts to beautify their living spaces and make them more comfortable. One of the most important is the Pleat Curtain. With the so-called Glass Balcony Curtain, its usage area is much larger. It adds a different atmosphere to spaces with its different color and fabric options. Özyay Company is one of the leading companies in the sector with its rich color and fabric options. All systems and components are its own patented products.



POLYESTER SYSTEMS LİNA SERİSİ / LINA SERIES

40 renkten oluşan perde portföyümüzün en önemli serisidir. 16 renkten oluşan geniş renk alternatifi mevcuttur, görüntü ve kapatılabilirlik oranı %55-60 oranındadır. rekabetçi fiyatıyla en çok tercih edilen serimizdir. Özel deseninden dolayı mekanlarınıza estetik bir görünüm sağlar,

Lina series is the most important series of our curtain portfolio consisting of 40 colors. It has wide color alternatives consisting of 16 colors, its image and coverage ratio is 55-60%. It is our most preferred series with its competitive price. It provides an aesthetic appearance to your spaces due to its special pattern.

01



LİNA SERİSİ / LINA SERIES



AKS - 1050

BEYAZ / WHITE



AKS - 1051

GRI / GREY



AKS - 1052

KREM / CREAM



AKS - 1053

BEJ / BEIGE

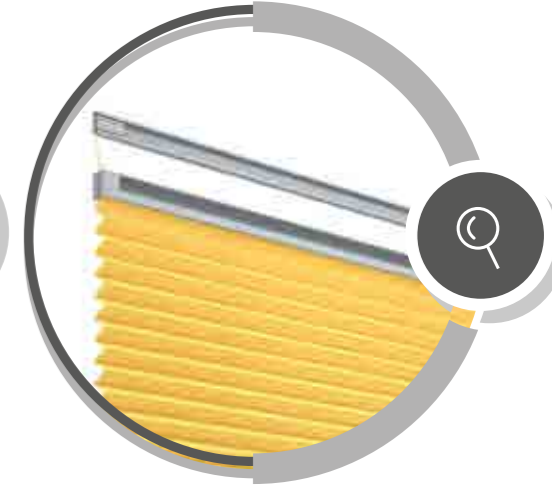

AKS - 1054

SARI / YELLOW



AKS - 1055

TURUNCU / ORANGE



AKS - 1056

GÜL KURUSU / DRIED ROSE



AKS - 1057

KIRMIZI / RED

LINA SERIES





LİNA SERİSİ / LINA SERIES

LINA SERIES

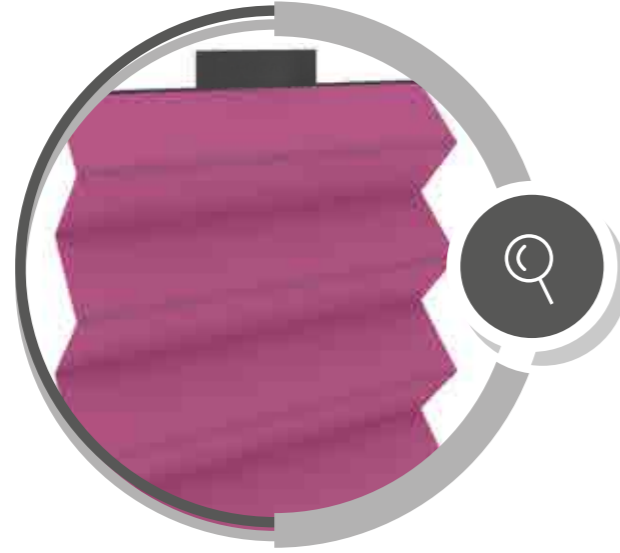

AKS - 1058

MÜRDÜM / DAMSON



AKS - 1062

KAHVE / BROWN



AKS - 1059

YEŞİL / GREEN



AKS - 1060

MAVİ / BLUE



AKS - 1061

PETROL / OIL COLOR



AKS - 1063

VİZON / MINK



AKS - 1064

ANTRESİT / ANTHRACITE GRAY



AKS - 1065

SİYAH / BLACK

HİRA SERİSİ / HIRA SERIES

HIRA SERIES



AKS - 3300

VİZON - VİZON / MINK - MINK

PERDE SİSTEMLERİ

Sektörde Black Out diye tabir edilen serimizdir. %100 oranında görüntü kapatma sağlanır. İki farklı kumaşın arasında özel bir Teflon malzeme yerleştirilerek özel olarak üretilir. Şimdilik 4 rengi mevcuttur. Çift renk kumaş olması sebebiyle farklı renklerde çift taraflı renk kullanılabilir, en önemli özelliğinden birisi bilhassa yurt dışında tercih edilen kış bahçesi sistemlerinde kasalı olarak tavan kısmına uygulanarak güneş ışınlarının kesilmesine yardımcı olur, en çok tercih edilen serilerimizdendir.



AKS - 3301

VİZON - KAHVE / MINK - BROWN



AKS - 3302

VİZON - GRİ / MINK GREY



AKS - 3300

VİZON-ANTI.GRİ / MINK-ANT.GRAY



CURTAIN SYSTEMS

It is our series called Black Out in the industry. It provides 100% coverage. It is specially produced by placing a special Teflon material between two different fabrics. Currently, it is available in 4 colors.

Double-sided color can be used due to the fact that it is doublecolored. It is the most preferred system in the countries we export to. It helps to cut the sun rays by being applied to the ceiling part in winter garden systems

YAZ SERİSİ / YAZ SERIES

YAZ SERİSİ



AKS - 5200

DESENLİ KREM / PATTERNED CREAM

PERDE SİSTEMLERİ

Özel desenli kumaş yapısı sayesinde çok tercih edilen bir serimizdir. Görüntü kapatma oranı %65-70 civarındadır. Yurt dışı müşterilerimizin çok tercih ettiği bir serimizdir. Dört ana rengi mevcuttur, özel deseni ve renkleri sayesinde mekanlarınıza güzel bir estetik katar.



AKS - 5201

DESENLİ GRİ / PATTERNED GRAY



AKS - 5202

DESENLİ KAHVE / PATTERNED BROWN



AKS - 5203

DESENLİ ANT. / PATTERNED ANT



CURTAIN SYSTEMS

It is a highly preferred series due to its special patterned fabric structure. The image coverage rate is around 65-70%. It is a series that is highly preferred by our customers abroad. It has four main colors, it provides an aesthetic appearance to your spaces thanks to its special patterns and colors

GÜNEŞ SERİSİ / GÜNEŞ SERIES

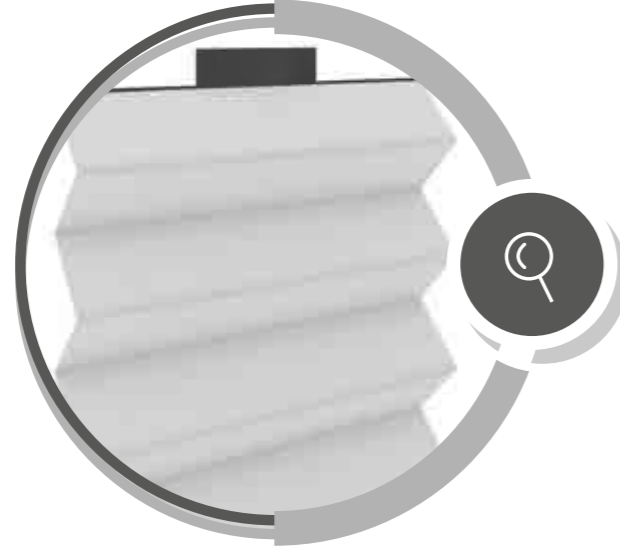
**AKS - 2400**

GRI / GREY

PERDE SİSTEMLERİ

Görüntü kapatma oranı olarak Hira serimize (Black Out) en yakın seri olarak adlandırabiliriz. Karartma oranı %90 civarındadır, dört rengi mevcuttur. Kumaş yapısı diğer serilere göre daha kalındır. Black Out kumaşların uygulanacağı mekanlara ekonomik anlamda alternatif tercihtir.

**AKS - 2401**

ÇAKIL GRİSİ / PEBBLE GREY

**AKS - 2402**

KAHVE / BROWN

**AKS - 2403**

GRAFİT GRİSİ / GRAPHİTE GREY

GÜNEŞ SERİSİ



CURTAIN SYSTEMS

We can call it the closest series to our Hira series (Black Out) in terms of coverage ratio. The blackout ratio is around 90%. It is available in four colors. The fabric structure is thicker than other series. It is an economical alternative choice for the places where Black Out fabrics will be applied

HİHAL SERİSİ / HİHAL SERIES

HİHAL SERIES

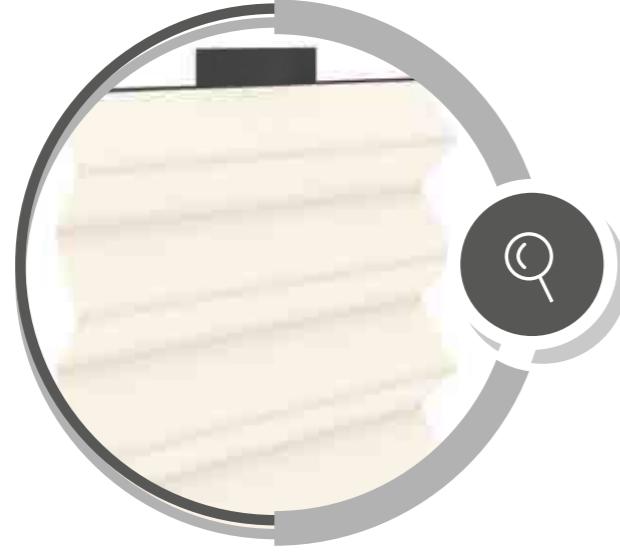
**AKS - 5400**

KREM / CREAM

PERDE SİSTEMLERİ

Lina Serimizle benzer özellikleri olan bir serimizdir. Özel bir doku deseniyle ayrışır. En çok tercih edilen dört rengi mevcuttur. Krem ve Antrasit gri renkleri çokca tercih edilir.

CURTAIN SYSTEMS

It has similar features with our Lina Series. It differs with its special pattern. The four most preferred colors are Cream and Anthracite gray

**AKS - 5401**

GRI / GRAY

**AKS - 5402**

KAHVE / BROWN

**AKS - 5403**

ANT. GRI / ANT. GR.

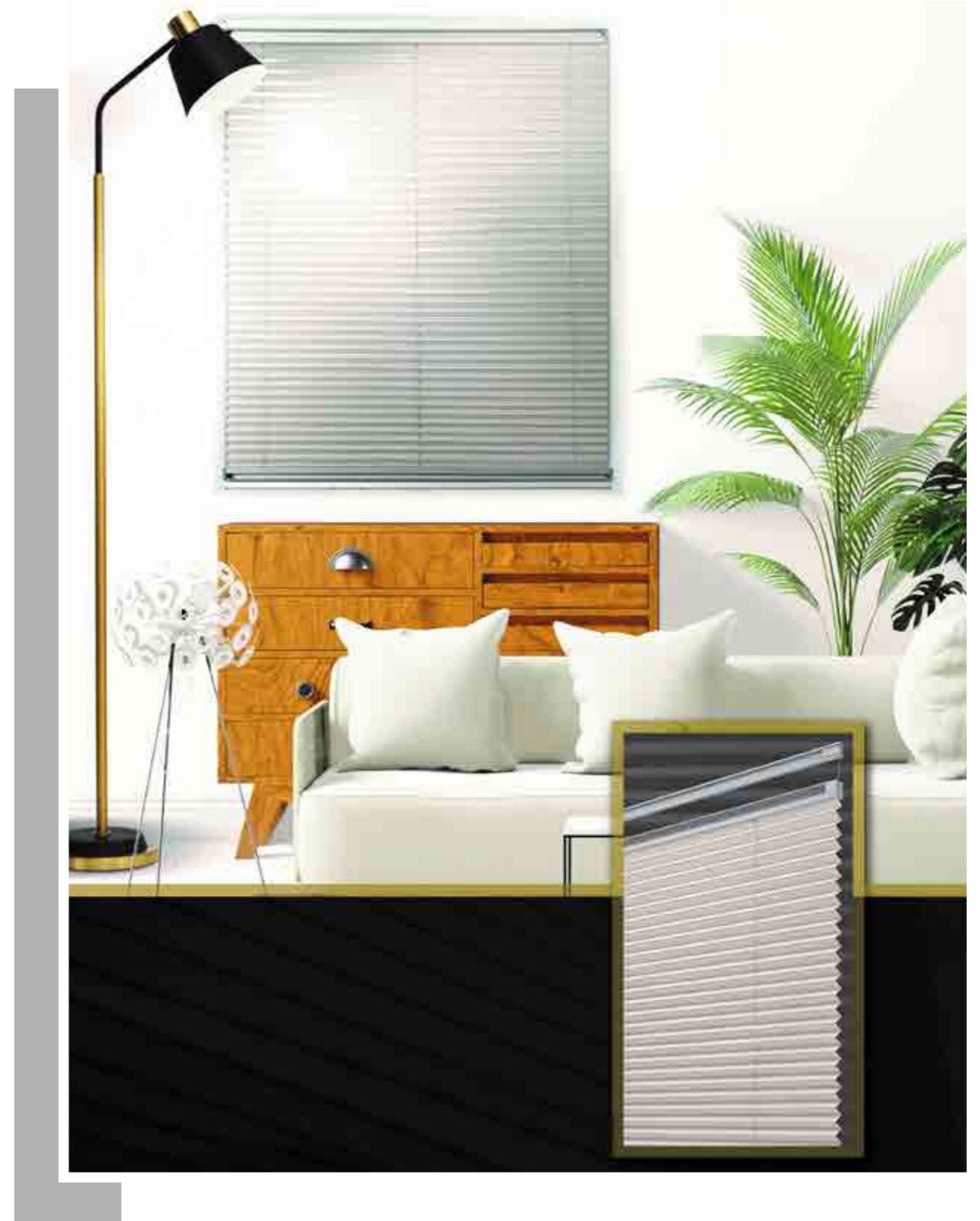

BAHAR SERİSİ / BAHAR SERIES

BAHAR SERIES

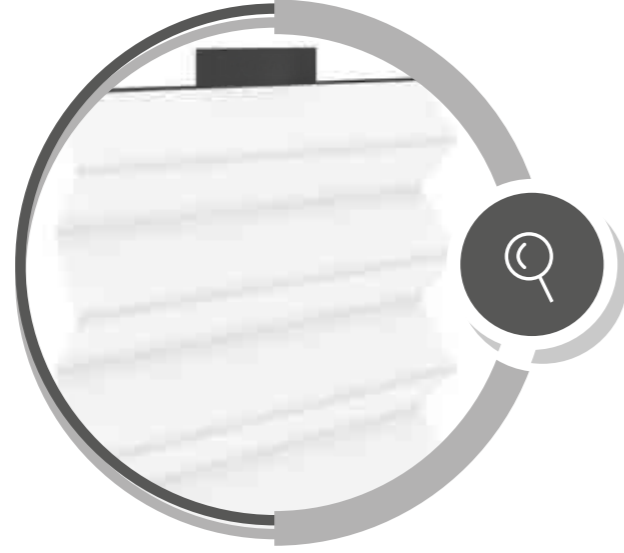
**AKS - 5300**

BEYAZ / WHITE

PERDE SİSTEMLERİ

İnce ve sık dokuma yapısına sahip bir serimizdir. Hafif parlak bir yüzey yapısı vardır. Projelerde sıklıkla tercih edilen serimizdir. Pvc doğramalarda renk uyumu olduğundan pencerelerde sıkça tercih edilir.

CURTAIN SYSTEMS

It is a series with a fine and ensely woven structure. It has a light lossy surface structure. It is generally preferred in projects. It is generally preferred for windows because it has color harmony in PVC joiner

**AKS - 5301**

GRİ / GRAY

**AKS - 5302**

KAHVE / BROWN

**AKS - 5303**

VİZON / MINK



VEGA SERİSİ / VEGA SERIES

VEGA SERIES



AKS - 2700

KREM / CREAM

PERDE SİSTEMLERİ

Örme tarzı diye tabir ettiğimiz özel bir dokuma deseni vardır. Hilal serimizle benzer özelliklere sahiptir. Özel renkleri sayesinde Kış Bahçesi diye tabir ettiğimiz mekanlarda sıkça tercih edilir.

CURTAIN SYSTEMS

We have a special weaving pattern, which we call as knitting style. It has similar features with our Hilal series. Thanks to its special colors, it is frequently preferred in places we call Winter Garden



AKS - 2701

KAHVE / BROWN



AKS - 2702

YEŞİL / GREEN



AKS - 2703

GRİ / GREY





CAM BALKON PERDESİ / CEILING CURTAINS



ISICAM BALKON PERDESİ / GLASS BALCONY





CAM BALKON PERDE SİSTEMİ GLASS BALCONY CURTAIN SYSTEMS



AKSPRF - 01

BEYAZ / WHITE



AKSPRF - 02

GRI / GRAY



AKSPRF - 03

KAHVE / BROWN



AKSPRF - 04

ANTRASİT GRI / ANTHRACITE GRAY



AKSPRF - 05

KREM / CREAM



AKSPRF - 06

SİYAH / BLACK



AKSPRF - 07

VİZON / VIZON

CAM BALKON PERDE AKSESUARI GLASS BALCONY CURTAIN ACCESSORIES



AKS - 01

GRI / GREY



AKS - 02

BEYAZ / WHITE



AKS - 03

KAHVE / BROWN



AKS - 04

SİYAH / BLACK



AKS - 05

KREM / CREAM

Perde Aksesuar set kolilerimizde 100'er adet setler şeklinde tedariki sağlanmaktadır.100'lük set kolimizin içinde 4 adet alüminyum köşe kapağı 4 adet montaj alt üst bağlantısı 4 adet ip kilitleme clipsi(2 parça)ve yeterli miktarda özel montaj vidası bulunmaktadır. Zengin renk seçeneğiyle perde kumaşına ve alüminyum rengine uygun çeşitliliği mevcuttur.Bu renkler;beyaz,kahve,siyah,gri krem' dir,

Our Curtain Accessory set boxes are supplied in sets of 100 each. There are 4 aluminum corner caps, 4 mounting lower and upper connections, 4 rope locking clips (2 pieces) and a sufficient amount of special mounting screws in our 100 set box. There is a variety suitable for the fabric and aluminum color with the color option. These colors are white, brown, black, gray cream.



SLIM PERDE PROFİLİ

SLIM CURTAIN PROFILE



PLİSE PERDE İPİ

PLISSE CURTAIN ROPE



SLIM PERDE AKSESUAR SİSTEM

SLIM CURTAIN ACCESSORY SET



AKS - 2017

SİYAH / BLACK

Perde Aksesuar set kolilerimizde 100'er adet setler şeklinde tedariki sağlanmaktadır. 100'lük set kolimizin içinde 4 adet alüminyum köşe kapağı 4 adet montaj alt üst bağlantısı 4 adet ip kilitleme clipsi (2 parça) ve yeterli miktarda özel montaj vidası bulunmaktadır. Zengin renk seçeneğiyle perde kumaşına ve alüminyum rengine uygun çeşitliliği mevcuttur. Bu renkler; beyaz, kahve, siyah, gri krem'dir,

Our Curtain Accessory set boxes are supplied in sets of 100 each. There are 4 aluminum corner caps, 4 mounting lower and upper connections, 4 rope locking clips (2 pieces) and a sufficient amount of special mounting screws in our 100 set box. There is a variety suitable for the fabric and aluminum color with the color option. These colors are white, brown, black, grey cream.



AKS - 2018

BEYAZ / WHITE



AKS - 2019

KREM / CREAM



AKS - 2020

GRI / GREY



AKS - 2021

KAHVE / BROWN

ISICAM CAM BALKON SERİSİ /LINA SERIES

GLASS BALCONY WITH THERMOPANE SERIES

PERDE SİSTEMLERİ

Bazı cam balkon modellerinde (ısıcamlı) alternatif bir çözümdür ince alüminyum yapısı sayesinde perde ve camın uyum içinde kullanılmasına sağlar

CURTAIN SYSTEMS

It is an alternative solution for some glass balcony models. Owing to its thin aluminum structure, it allows the use of curtain and glass in harmony.



AKS - 2400

GRI / GREY



AKS - 2401

ÇAKIL GRI / PEBBLE GREY



AKS - 2402

KAHVE / BROWN



AKS - 2403

GRAFİT GRI / GRAPHITE GREY

ISICAM CAM BALKON SERİSİ /LINA SERIES

GLASS BALCONY WITH THERMOPANE SERIES

PERDE SİSTEMLERİ

40 renkten oluşan perde portfolyumuzun en önemli serisidir. 16 renkten oluşan geniş renk alternatifi mevcuttur, görüntü ve kapatılabilirlik oranı %55-60 oranındadır. rekabetçi fiyatıyla en çok tercih edilen serimizdir. özel deseninden dolayı mekanlerinize estetik bir görünüm sağlar,

CURTAIN SYSTEMS

Lina series is the most important series of our curtain portfolio consisting of 40 colors. It has wide color alternatives consisting of 16 colors, its image and coverage ratio is 55-60%. It is our most preferred series with its competitive price. It provides an aesthetic appearance to your spaces due to its special pattern.



AKS - 2700

KREM / CREAM



AKS - 2701

KAHVE / BROWN

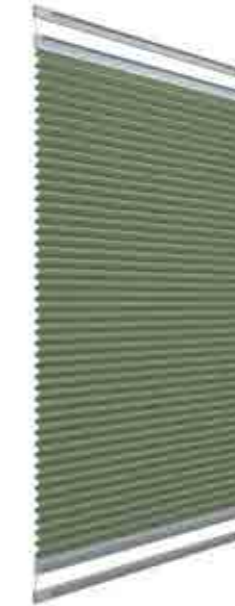

AKS - 2702

YEŞİL / GREEN



AKS - 2703

GRI / GREY

CAM BALKON PERDESİ, GECE GÜNDÜZ SİSTEMİ GLASS BALCONY CURTAIN, DAY/NIGHT SYSTEM



GECE GÜNDÜZ PROFİL AKSESUAR DAY AND NIGHT PROFILE ACCESSORY SET



Gece gündüz sistemi perde sistemimizin özel bir serisidir. İki farklı kumaş uygulanabilir. Özel bir alüminyum ve aksesuar sistemiyle kumaş birbirinden ayrılır, farklı iki desen ve renk kumaş isteğe göre kullanılabilir. (örnek: bir taraf black out kumaş bir taraf lina serisi uygulanabilir.

The Night and Day system is a special series of ours. Two different fabrics can be used. (For example, "Black Out" fabric on one side and "Lina" Series fabric on the other side) Fabrics are separated from each other with a special aluminum accessory.

PERDE SİSTEMLERİ YAPIŞTIRMA PROFİLİ CURTAIN SYSTEMS ADHESIVE PROFILE



AKS - 2010

KREM / CREAM



AKS - 2011

GRI / GREY



AKS - 2012

KAHVE / COFFEE



AKS - 2013

SIYAH / BLACK



AKS - 2014

BEYAZ / WHITE



KARAVAN SİNEKLİK PERDE PROFİLİ (KASA)

CARAVAN FLY SCREEN CURTAIN ACCESSORY SYSTEM (CASE)



KARAVAN SİNEKLİK PERDE PROFİLİ (KANAT)

CARAVAN FLY SCREEN CURTAIN PROFILE (WING)



KARAVAN SİNEKLİK AKSESUAR PERDE SİSTEM

CARAVAN FLY SCREEN CURTAIN ACCESSORY SYSTEM



AKS - 2022-1

BEYAZ / (WHITE)



AKS - 2022-2

KREM / (CREAM)



AKS - 2022-3

SİYAH / BLACK





ŞERİT 15 MM STRIP 15 MM



Plise Sineklik Pvc Bantlı Şerit sinekliğin tülüne yapıştırılarak tül ile alüminyum bağlantısını sağlamaktadır. Bu ürünün en büyük özelliği ısıya karşı dayanıklı Pvc malzemeden üretilmesidir. Üzerindeki çift taraflı bant dış hava şartlarında, sıcakta ve soğukta özelliğini yitirmemelidir. Pvc Şeritler üretildikten sonra firmamız tarafından sıcak hava şartlarında dayanımı kontrol edilmekte ve bu ürün için özel üretilen bantlar yapıştırılmaktadır. **AK PLİSE** markalı Pvc Şeritlerin **10 yıl garanti süresi** vardır

Plise Fly Screen Pvc Taped Strip is attached to the tulle of the fly screen and provides the aluminum connection with the tulle. The biggest feature of this product is that it is produced from heat resistant PVC material. The double-sided tape on it does not lose its exterior, hot and cold properties. After the PVC Strips are produced, their strength is checked by our company in hot weather conditions and the tapes specially produced for this product are adhered. AK PLİSE branded PVC Strips have a warranty period of 10 years.

İP ROPE

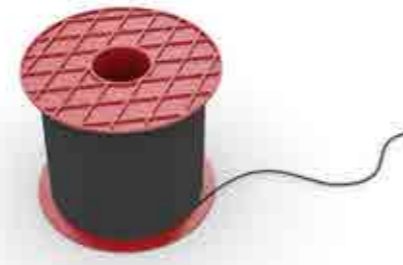

Sineklik sistemlerinin en önemli bileşenlerinden biri olan sineklik ipleri mekanizmanın sorunsuz çalışabilmesi için pek çok bitirme işleminden geçirilmektedir.

Kullanım sırasında tül sisteminin formunun bozulmasını engellemek için ısı işleminden geçirilmekte uzaması azaltılmakta ve sürtünme dayanımı artırılmaktadır.

Flat and triangular magnets; in measurements above a certain standard, some changes are made in order for the system to work healthily. One of the important details is the double system we use in large sizes, it provides an easier use and double-sided wing is used. It allows it to work. Flat and triangular magnets are preferred, the triangular magnet feature does not prevent the system from working during production and allows minor errors to be eliminated.

KUŞ GÖZÜ EYELET



Plise sinekliğin ip'in geçişinde kullanılan sineklik ve perde ürünlerinde kullanabileceğiniz metal özel kaplamalı kuşgözü kapsül. Bu ürünü tulumba presinde ve otomatik makinalarda delici ve çakma kalıpları kullanarak uygulayabilirsiniz. Ürün sac malzemeden yapılmış, ve alüminyum kaplamadır.

It is a metal specially coated capsule that you can use in fly screen systems and curtain products used in the passage of pleated fly screen systems. You can apply this product in pump presses and automatic machines by using piercing and hammering dies. The product is made of sheet material and has an aluminum coating.

MANTAR VİDA CORK HEAD SCREW



Mantar başlı üretim vidası; Şerite yapıştırılan tülün kasa profiline sabitlemesinde kullanılır, en önemli özelliği geniş başlı olması sebebiyle tülün yırtılmasına engel olur ve güçlü bir mukavemet sağlar.

Cork Head Screw, is used to fix the plisse polyester mesh attached to the strip, to the frame profile. The most important feature, owing to its wide head, prevents the polyester mesh from tearing and provides a strong strength.

KARAVAN SİNEKLİK PERDE SİSTEMİ
CARAVAN FLY SCREEN CURTAIN SYSTEM



ÜRETİM PARKURU / **PRODUCTION PARK**

MAKİNA KALIPLARI / **MACHINE MOLDS**

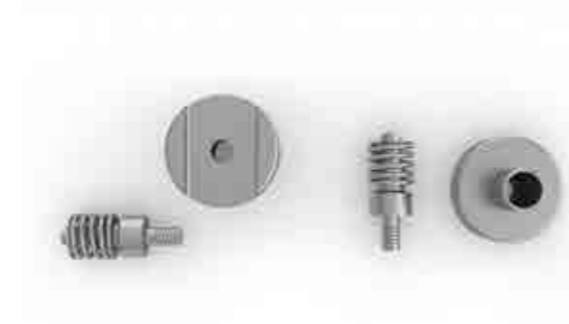

KUŞ GÖZÜ DELME

EYELET DRILLING



KUŞ GÖZÜ MANUEL ÇAKMA

MANUEL EYELET PRESS MOLD



KUŞ GÖZÜ ELEKTİRİKLİ ÇAKMA

ELECTRONIC EYELET PRESS MOLD



ÇENGEL

HOOK



PERDE DELME KALIBI

CURTAIN DRILLING MOLD



PERDE ÇEKME APARATI

CURTAIN DRAWING MOLD

ÜRETİM PARKURU / PRODUCTION PARK

KUŞ GÖZÜ DELME ve ÇAKMA MAKİNASI

Kuş Gözü Delme Makinesi; Sineklik ve Perde üretiminde kullanılan özel bir makinedir. Sineklik ve Perde üretimi yapılırken, tülün ve perdenin sabit kalmasını sağlayan özel bantlı şeritler kullanılır. Bu makine sayesinde tül, perde ve şeritin delme işlemi uygulanır. Özel Kalıbı sayesinde Kuş Gözü boyutunda şerit tül ve perdeye simetrik delikler açılır.

Kuş Gözü Çakma Makinesi; Delme makinesiyle aynı makinedir. Tek farkı kalıplarının farklı olmasıdır. Bu makinemizle Kuş Gözü Çakma işlemi uygulanır. Bir önceki makinemizde delme işlemi yaptığımız delme işlemi bu makinemizle Çakma işlemi yapılarak tül ve perdenin şerite montajı tamamlanır. Daha sonra tül ve perde işlemi toplanmaya (iplenmeye) hazır hale gelir.



ELECTRONIC EYELET PRESS MACHINE

Electronic eyelet press machine; Special used in mosquito net and curtain production. During the production of mosquito nets and curtains, special banded strips are used to keep the tulle and curtain stable. Thanks to this machine, tulle, curtain and ribbon are perforated. Thanks to its special mold, symmetrical holes are made in the size of the birds eye, on the ribbon tulle and curtain.

Electronic eyelet press machine; It is the same machine as the drilling machine. The only difference is that the molds are different. With this machine, Bird Eye Attaching process is applied. The assembly of the tulle and curtain to the strip is completed by hammering in the place where we drilled in our previous machine, with this machine. Then the tulle and curtain process becomes ready for gathering.



PERDE KESİM MAKİNASI

Tül Perde Kesim Makinesi; Tül Perde Kesim Makinesi Dizaynı Firmamız tarafından yapılan özel bir makinedir. Özel ambalajlı ve özel kolisinde üretime gelen tül ve perdelerimiz üretim ölçüsüne göre kesimi yapılır. Sorunsuz ve simetrik bir şekilde bu makine sayesinde sağlanır. Özel kilitlemesi sayesinde tül ve perdeler tam ölçüsünde kesilir.

MANUEL PRESS

Tulle curtain cutting machine is a special machine designed by our company. Thanks to this machine, our tulle and curtains, which come to production in special packaging and in special boxes, are cut according to the production size in a smooth and symmetrical way. Thanks to its special locking, tulle and curtains are cut to size.



ÜRETİM PARKURU / PRODUCTION PARK

İP İZİ DELME MAKİNASI

İp iz tül ve perde delme makinesi sineklik ve perde üretimi için gerekli önemli bir makinedir. Sütun matkap diye de adlandırabiliriz. Özel uçları ve kalıpları sayesinde tül ve perdenin sorunsuz simetrik bir şekilde delinmesi sağlanır. Makine üretim tezgahı üzerine sabitlenir. Şerit metre ve makinenin önüne paralel bir şekilde özel hazırlanan kalıpla delme işlemi gerçekleştirilir.



PUNCHING MACHINE FOR STRING TRAIL BOSCH

Punching machine is an important machine for the production of fly screen and curtains. We can also call it a column drill. Thanks to its special tips and molds, tulle and curtains are drilled in a symmetrical manner. The machine is fixed on the production bench. Drilling is performed with a specially prepared mold parallel to the tape measure and the machine.



PERDE İP AYARLAMA TEZGAHI

İpleme tezgahı: perde Üretimi yapıldıktan sonra perde montajı özel ölçüye göre yapılır. Bu tezgahımızın en önemli özelliği perde üretimi bittikten sonra özel bant sistemi sayesinde perde sistemini montaja hazır hale getirmesidir. Perde bant sistemi üzerine yerleştirilir üzerindeki ölçüleme rayıyla ölçüsünde klipsler kilitlenir. Montaj esnasında sadece vidalama veya yapıştırma işlemi yapılarak klipsler yerlerine yerleştirilir ve montaj işlemi bitmiş olur.

PUNCHING MACHINE FOR STRING TRAIL BOSCH

After curtain production is done, curtain assembly is made according to a special size.

The most important feature of this workbench is that it makes the curtain system ready for assembly owing to the special band system after the curtain production is finished. The curtain is placed on the band system and the clips are locked in place with the measuring rail on it.

During assembly, only screwing and gluing operations are performed, the clips are placed and the assembly process is completed.





PLİSE SİNEKLİK PERDE SİSTEMLERİ
FLY SCREEN AND CURTAIN SYSTEMS

PRODUCTION PARK \ ÜRETİM PARKURU



PLİSE SİNEKLİK
SİSTEMLERİ

www.akplise.com

SİNEKLİK & PERDE SİSTEMLERİ

FLY SCREEN AND CURTAIN SYSTEMS



www.akperde.com



PLİSE SİNEKLİK
SİSTEMLERİ

SİNEKLİK & PERDE SİSTEMLERİ

Adres / Adress:

Fatih Mah. Gölbaşı Sok. No:9

Sultanbeyli / İSTANBUL / **TÜRKİYE**

.....
Tel / Phone: +90 545 542 91 18

mail: info@akplise.com

www.akplise.com

